

Draft 3 – March 24, 2005

#### COMMENTS REGARDING THIS DRAFT:

1. OC from 25 to 100, calculated separately will be added if long term applicable

#### OPEN ITEMS:

1. New Pictures are needed as follows:
  - Fig A1.7 - showing the engine coolant-in t/c (Section 8.6.2.3)
  - Fig A1.15 - showing Pre-Venturi t/c and pressure tap (Section 8.6.2.12)
2. Sections 11.4 - 11.6, 11.8, and parts of Section 13 - reference and non-reference requirements, and precision tbd once PC-10 matrix is completed.

ASTM Designation: DXXXX - XX

#### STANDARD TEST METHOD FOR EVALUATION OF DIESEL ENGINE OILS IN THE T-12 EXHAUST GAS RECIRCULATION DIESEL ENGINE<sup>1</sup>

This standard is issued under the fixed designation D XXXX; the number immediately following the designation indicates the year of original adoption or, in the case of revision, the year of last revision. A number in parentheses indicates the year of last reapproval.

#### 1. Scope

- 1.1 This test method is commonly referred to as the Mack T-12.<sup>2</sup> This test method covers an engine test procedure for evaluating diesel engine oils for performance characteristics, including lead corrosion and wear of piston rings and cylinder liners in an engine equipped with exhaust gas recirculation and running on ultra-low sulfur diesel fuel.<sup>3</sup>
- 1.2 The values stated in either SI or inch-pound units are to be regarded separately as the standard. Within the test method, the inch-pound units are shown in parentheses when combined with SI units.
- 1.3 *This standard does not purport to address all of the safety concerns, if any, associated with its use. It is the responsibility of the user of this standard to establish appropriate safety and health practices and determine the applicability of regulatory limitations prior to use. See Annex A.6 for specific Safety Precautions.*

#### 2. Referenced Documents

- 2.1 *ASTM Standards*
  - D 86 Test Method for Distillation of Petroleum Products<sup>4</sup>
  - D 93 Test Methods for Flash Point by Pensky-Martens Closed Tester<sup>4</sup>
  - D 97 Test Method for Pour Point of Petroleum Products<sup>4</sup>
  - D 129 Test Method for Sulfur in Petroleum Products (General Bomb Method)<sup>4</sup>

D 130 Test Method for Detection of Copper Corrosion from Petroleum Products by the Copper Strip Tarnish Test<sup>4</sup>

D 235 Standard Specification for Mineral Spirits (Petroleum Spirits) (Hydrocarbon Dry Cleaning Solvent)<sup>4</sup>

D 287 Test Method for API Gravity of Crude Petroleum and Petroleum Products (Hydrometer Method)<sup>4</sup>

D 445 Test Method for Kinematic Viscosity of Transparent and Opaque Liquids (and the Calculation of Dynamic Viscosity)<sup>4</sup>

D 482 Test Method for Ash from Petroleum Products<sup>4</sup>

D 524 Test Method for Ramsbottom Carbon Residue of Petroleum Products<sup>4</sup>

D 613 Test Method for Ignition Quality of Diesel Fuels by the Cetane Method<sup>4</sup>

D 664 Test Method for Acid Number of Petroleum Products by Potentiometric Titration<sup>4</sup>

D 976 Test Methods for Calculated Cetane Index of Distillate Fuels<sup>4</sup>

D 1319 Test Method for Hydrocarbon Types in Liquid Petroleum Products by Fluorescent Indicator Absorbance<sup>4</sup>

D 2274 Test Method for Oxidation Stability of Distillate Fuel Oil (Accelerated Method)<sup>4</sup>

D 2500 Test Method for Cloud Point of Petroleum Products<sup>4</sup>

D 2622 Test Method for Sulfur in Petroleum Products by X-Ray Spectrometry<sup>5</sup>

D 2709 Test Method for Water and Sediment in Distillate Fuels by Centrifuge<sup>5</sup>

D 4052 Test Method for Density and Relative Density of Liquids by Digital Density Meter<sup>5</sup>

D 4485 Specification for Performance of Engine Oils<sup>5</sup>

D 4737 Test Method for Calculated Cetane Index by Four Variable Equation<sup>6</sup>

D 4739 Test Method for Base Number Determination by Potentiometric Titration<sup>6</sup>

D 5185 Test Method for Determination of Additive Elements, Wear Metals, and Contaminants in Used Lubricating Oils by Inductively Coupled Plasma Atomic Emission Spectrometry<sup>6</sup>

D 5302 Test Method for Evaluation of Automotive Engine Oils for Inhibition of Deposit Formation and Wear in a Spark-Ignition Internal Combustion Engine Fueled with Gasoline and Operated Under Low-Temperature, Light Duty Conditions<sup>6</sup>

D 5844 Test Method for Evaluation of Automotive Engine Oils for Inhibition of Rusting<sup>6</sup>

D 5967 Test Method for Evaluation of Diesel Engine Oils in T-8 Diesel Engine<sup>7</sup>

D 6483 Test Method for Evaluation of Diesel Engine Oils in T-9 Diesel Engine<sup>7</sup>

D 6681 Test Method for Evaluation of Engine Oils in a High Speed, Single-Cylinder Diesel Engine – Caterpillar 1P Test Procedure<sup>7</sup>

E 29 Practice for Using Significant Digits in Test Data to Determine Conformance With Specifications<sup>8</sup>

E 178 Standard Practice for Dealing With Outlying Observations<sup>8</sup>

E 344 Terminology Relating to Thermometry in Hydrometry<sup>9</sup>

### 3. Terminology

#### 3.1 Definitions

- 3.1.1 *blind reference oil, n* – a reference oil, the identity of which is unknown by the test facility.
- 3.1.1.1 *Discussion* – This is a coded reference oil that is submitted by a source independent from the test facility. **(D 5844)**
- 3.1.2 *blowby, n* – in internal combustion engines, the combustion products and unburned air-and-fuel mixture that enter the crankcase. **(D 5302)**
- 3.1.3 *calibrate, v* – to determine the indication or output of a measuring device with respect to that of a standard. **(E 344)**

- 3.1.4 *candidate oil, n* – an oil that is intended to have the performance characteristics necessary to satisfy a specification and is intended to be tested against that specification. **(D 5844)**
- 3.1.5 *exhaust gas recirculation (EGR), n* – the mixing of exhaust gas with intake air to reduce the formation of nitrogen oxides (NO<sub>x</sub>). **(Automotive Handbook<sup>10</sup>)**
- 3.1.6 *heavy-duty, adj.* – in internal combustion engine operation, characterized by average speeds, power output and internal temperatures that are close to the potential maximums. **(D 4485)**
- 3.1.7 *heavy-duty engine, n* – in internal combustion engines, one that is designed to allow operation continuously at or close to its peak output. **(D 4485)**
- 3.1.8 *non-reference oil, n* – any oil other than a reference oil; such as a research formulation, commercial oil or candidate oil. **(D 5844)**
- 3.1.9 *non-standard test, n* – a test that is not conducted in conformance with the requirements in the standard test method; such as running on an uncalibrated test stand, using different test equipment, applying different equipment assembly procedures, or using modified operating conditions. **(D 5844)**
- 3.1.10 *oxidation, n* – of engine oil, the reaction of the oil with an electron acceptor, generally oxygen, which can produce deleterious acidic or resinous materials often manifested as sludge formation, varnish formation, viscosity increase, or corrosion, or combination thereof. **(Sub. B Glossary)<sup>11</sup>**
- 3.1.11 *reference oil, n* – an oil of known performance characteristics, used as a basis for comparison.
- 3.1.11.1 *Discussion* – Reference oils are used to calibrate testing facilities, to compare the performance of other oils, or to evaluate other materials (such as seals) that interact with oils. **(D 5844)**
- 3.1.12 *sludge, n* – in internal combustion engines, a deposit, principally composed of insoluble resins and oxidation products from fuel combustion and the lubricant, that does not drain from engine parts but can be removed by wiping with a cloth. **(D 5302)**
- 3.1.13 *standard test, n* – a test on a calibrated test stand, using the prescribed equipment according to the requirements in the test method, and conducted according to the specified operating conditions.
- 3.1.13.1 *Discussion* – The specified operating conditions in some test methods include requirements for determining a test's operational validity. These requirements are applied after a test is completed and can include (1) mid-limit ranges for the *average values* of primary and secondary parameters that are narrower than the specified control ranges for the *individual values*, (2) allowable *deviations* for *individual* primary and secondary parameters for the specified control ranges, (3) downtime limitations, and (4) *special* parameter limitations. **(D 5844)**
- 3.1.14 *varnish, n* – in internal combustion engines, a hard, dry, generally lustrous deposit that can be removed by solvents but not by wiping with a cloth. **(D 5302)**

3.1.15 *wear, n* – the loss of material from, or relocation of material on, a surface.

3.1.15.1 Discussion – Wear generally occurs between two surfaces moving relative to each other, and is the result of mechanical or chemical action or by a combination of mechanical and chemical action. **(D 5302)**

#### **4. Summary of Test Method**

4.1 The test operation involves use of a Mack E-TECH V-MAC III diesel engine with Exhaust Gas Recirculation (EGR). A warm-up and a 1-h break-in are followed by a two-phase test consisting of 100 h at 1800 r/min and 200 h at 1200 r/min, both at constant speed and load.

4.2 Take oil samples periodically and analyze for viscosity increase and wear metals content.

4.3 Rebuild the engine prior to each test. Disassemble, solvent-clean, measure, and rebuild, the engine power section using all new pistons, rings, cylinder liners, and connecting rod bearings, in strict accordance with furnished specifications.

4.4 Solvent-clean the engine crankcase and replace worn or defective parts.

4.5 Equip the test stand with appropriate accessories for controlling speed, load, and various engine operating conditions.

#### **5. Significance and Use**

5.1 This test method was developed to evaluate the wear performance of engine oils in turbocharged and intercooled four-cycle diesel engines equipped with EGR and running on ultra-low sulfur diesel fuel. Obtain results from used oil analysis and component measurements before and after test.

5.2 The test method may be used for engine oil specification acceptance when all details of the procedure are followed.

#### **6. Apparatus**

##### *6.1 General Description*

6.1.1 The test engine is a Mack E-TECH V-MAC III, electronically controlled fuel injection with six electronic unit pumps, using 2002 cylinder heads, P/N 11GBA81025 (Annex A2). It is an open-chamber, in-line, six-cylinder, four-stroke, turbocharged, charge air-cooled, and compression ignition engine. The bore and stroke are 124 by 165 mm (4 7/8 X 6 1/2 in.), and the displacement is 12 L (728 in<sup>3</sup>).

6.1.2 The ambient laboratory atmosphere shall be relatively free of dirt and other contaminants as required by good laboratory standards. Filtering air, controlling temperature, and controlling humidity in the engine buildup area helps prevent accumulation of dirt and other contaminants on engine parts and aids in measuring and selecting parts for assembly.

##### *6.2 The Test Engine*

##### *6.2.1 Mack T-12 Test Engine*

The engine is available from Mack Trucks, Inc. A complete parts list is shown in Table A2.1, Annex A2. Use test parts on a first-in/first-out basis.

## 6.2.2 *Engine Cooling System*

6.2.2.1 Use a new Mack coolant conditioner shown in Table A2.1, Annex A2, every test, to limit scaling in the cooling system. Pressurize the system to 103 kPa (15 psi) at the expansion tank. Use the coolant shown in Section 7.3.1.

6.2.2.2 Use a closed-loop, pressurized external engine cooling system composed of a nonferrous core heat exchanger, reservoir, and water-out temperature control valve. The system shall prevent air entrainment and control jacket temperatures within the specified limit. Install a sight glass between the engine and the cooling tower to check for air entrainment and uniform flow in an effort to prevent localized boiling. Block the thermostat wide open.

6.2.2.3 Use a closed-loop, pressurized external EGR cooling system composed of a nonferrous core heat exchanger, reservoir, and coolant-out temperature control valve. The system shall prevent air entrainment and control jacket temperatures within the specified limit. Install a sight glass between the EGR coolers and the cooling tower to check for air entrainment and uniform flow in an effort to prevent localized boiling. The coolant flow direction is to be parallel (concurrent) with the EGR gas flow. Every reasonable attempt should be made to ensure that the EGR temperatures leaving the coolers are very similar. Figure A1.3, Annex A1, shows the coolant flow to and from the EGR coolers, respectively.

## 6.2.3 *Auxiliary Oil System*

To maintain a constant oil level in the pan, provide an additional 9.5 L (10 qt) sump by using a separate closed tank connected to the sump. Circulate oil through the tank at a rate of  $5.7 \pm 1.9$  L/min ( $1.5 \pm 0.5$  gal/min) with an auxiliary pump. The system schematic is shown in Fig. A1.1, Annex A1. The No. 6 and No. 8 lines are to have inside diameters of 10 mm (3/8 in.) and 13 mm (1/2 in.), respectively. Use a minimum No. 8 size vent line. Equivalent lines may be substituted for Aeroquip<sup>12</sup> lines provided they have the proper inside diameters.

6.2.3.1 Locate the auxiliary oil system suction line on the exhaust side of the oil pan, 127 mm (5.00 in.) down from the oil pan rail, and 178 mm (7.00 in.) back from the front of the pan. This location is directly above the oil sump temperature thermocouple. Refer to Fig. A1.4, Annex A1. Connect the auxiliary oil system return line to the power steering pump cover on the front timing gear cover. Refer to Fig. A1.5, Annex A1. Connect the auxiliary oil scale vent line to the top of the auxiliary oil sump bucket and the dipstick tube opening.

6.2.3.2 Viking Pump Model SG053514 shall be used as the auxiliary oil pumps. Pump speed is specified as 1725 r/min.<sup>13</sup>

## 6.2.4 *Oil Cooling System*

6.2.4.1 Use the oil cooler adapter blocks to mount the oil cooler to the engine. The adapter blocks are available from the supplier list in Annex A2.7, Annex A2.

6.2.4.2 Use the oil filter housing (part number 27GB525M) shown in Figure A1.8.

- 6.2.5 *Blowby Meter*  
Use a meter capable of providing data at a minimum frequency of 6 min. To prevent blowby condensate from draining back into the engine, the blowby line shall have a downward slope to a collection bucket. The collection bucket shall have a minimum volume of 18.9 L (5 gal). Locate the blowby meter downstream of the collection bucket. The slope of the blowby line downstream of the collection bucket is unspecified.
- 6.2.6 *Air Supply and Filtration*  
Use the Mack air filter element and the Mack filter housing shown in A2.3, Annex A2. Replace filter cartridge when 2.5 kPa (10 in. H<sub>2</sub>O) ΔP is reached. Install an adjustable valve (flapper) in the inlet air system at least 2 pipe diameters before any temperature, pressure and humidity measurement devices. Use the valve to maintain inlet air restriction within required specifications.
- 6.2.7 *Fuel Supply*  
Heating, cooling, or both of the fuel supply may be required, and a recommended system is shown in Fig. A1.2, Annex A1.
- 6.2.8 *Intake Manifold Temperature Control*  
Use stainless steel intake manifolds (P/N M10105GCX4332RSS for front manifold, M10105GCX5212RSS for rear manifold) available from the supplier listed in A2.2, Annex A2. Use a Modine intercooler to control intake manifold temperature (refer to A2.4, Annex A2). **Warning** – to minimize potential intake air condensation keep the intercooler out temperature above 30° C at all times of engine operation.
- 6.2.9 *Injection Timing Control*  
Remove the engine intake manifold temperature sensor. Use the intake manifold temperature to control injection timing according to the Temperature to Injection Timing Correlation shown in Annex A4.
- 6.2.10 *Oil Pump*  
Use a Mack P/B 315GC465BM oil pump. The oil pump is available from the supplier listed in A2.2, Annex A2.
- 6.2.11 *EGR Venturi Unit*  
Use a stainless steel EGR venturi unit, P/N 762GBX433SS, available from the supplier listed in A2.2, Annex A2.
- 6.2.12 *Fuel Pressure Regulator*  
Use a P/N 691GC227M2 fuel pressure regulator.
- 7. Engine Fluids**
- 7.1 *Test Oil*  
7.1.1 Approximately 151 L (40 gal) of test oil are required for the test.
- 7.2 *Test Fuel*  
Obtain the ultra-low sulfur diesel (ULSD) test fuel from the supplier shown in A2.6, Annex A2. The required fuel properties and tolerances are shown in Table 1.
- 7.3 *Coolant*

- 7.3.1 For the engine coolant, use demineralized water with less than 0.03 g/L (2 grains/gal) of salts or distilled water (do not use antifreeze solutions). Use Pencool 3000 coolant additive at the manufacturer's recommended rate. Pencool3000 may be obtained from the supplier shown in A2.8, Annex A2.
- 7.3.2 The EGR coolant is not specified and is at the discretion of the lab.
- 7.4 *Cleaning Materials*
- 7.4.1 Use a solvent that meets the requirements in Specification D 235, Type II, Class C for cleaning engine parts, refer to A2.5, Annex A2. (**Warning** - Use adequate safety precautions with all solvents and cleaners.) Other materials such as diesel fuel may be required by some labs in order to assure parts cleanliness.

**TABLE 1**  
**ULSD FUEL SPECIFICATION**

<b>Property</b>	<b>Specification</b>	<b>Test Method</b>
Additives	Lubricity additive only	
Distillation Range, °C, 90%	293 – 332	ASTM D 86
Specific Gravity	0.840 – 0.855	ASTM D 4052
API Gravity	34 – 37	ASTM D 4052
Corrosion, 3 h at 50 °C	1 max	ASTM D 130
Sulfur, mass ppm	7 – 15	ASTM D 5453
Flash Point, °C	54 min	ASTM D 93
Pour Point, °C	-18 max	ASTM D 97
Cloud Point, °C	Report	ASTM D 2500
Viscosity at 40 °C, cSt	2.0 – 2.6	ASTM D 445
Ash, weight %	0.005 max	ASTM D 482
Carbon Residue on 10% Bottoms	0.35 max	ASTM D 524
Net Heat of Combustion	Report	ASTM D 3338
Water and Sediment, volume %	0.05 max	ASTM D 2709
Total Acid Number	0.05 max	ASTM D 664
Strong Acid Number	0 max	ASTM D 664
Cetane Index	Report	ASTM D 976
Cetane Number	43 – 47	ASTM D 613
Accelerated Stability, mg/100 mL	1.5 max	ASTM D 2274
Composition		
Aromatics, wt %	26 – 31.5	ASTM D 5186
Olefins, vol %	Report	ASTM D 1319
Saturates, vol %	Report	ASTM D 1319
SLBOCLE, g	3100 min <sup>4</sup>	ASTM D 6078 <sup>4</sup>

<sup>4</sup> May be altered to be consistent with CARB or ASTM diesel fuel specifications.

## **8. Preparation of Apparatus at Rebuild**

### 8.1 *Cleaning of Parts*

#### 8.1.1 *Engine Block*

Thoroughly spray the engine with solvent to remove any oil remaining from the previous test and air-dry. Additionally, use of an engine parts washer shall be followed by a solvent wash.

- 8.1.2 *Rocker Covers and Oil Pan*  
Remove all sludge, varnish and oil deposits. Rinse with solvent and air-dry. Additionally, use of an engine parts washer shall be followed by a solvent wash.
- 8.1.3 *Auxiliary Oil System*  
Flush all oil lines, galleries and external oil reservoirs with solvent to remove any previous test oil and then air-dry.
- 8.1.4 *Oil Cooler and Oil Filter*  
Flush the oil cooler and filter lines with solvent to remove any previous test oil and then air-dry. Additionally, use of an engine parts washer shall be followed by a solvent wash.
- 8.1.5 *Cylinder Head*  
Clean the cylinder heads using a wire brush to remove deposits and rinse with solvent to remove any sludge and oil and then air-dry. Additionally, use of an engine parts washer shall be followed by a solvent wash.
- 8.1.6 *Intake Manifold*  
Clean the intake manifold before each test. Scrub the manifold using a nylon brush and solvent, and then wash the manifold using an engine parts cleaner.
- 8.1.7 *EGR Coolers*  
Replacing or cleaning of the EGR coolers is at the test laboratory's discretion. An example of a successful cleaning method is available from the TMC.
- 8.1.8 *EGR Venturi Unit*  
Clean the venturi before each test. Spray with solvent and scrub with a nylon brush.
- 8.2 *Valves, Seats, Guides, and Springs*  
Visually inspect valves, seats, and springs for defects or heavy wear and replace if necessary. Replacement of the valves, guides, and seat inserts for each test is recommended, but not required.
- 8.2.1 Replace and ream guides to  $0.9525 \pm 0.0013$  cm ( $0.3750 \pm 0.0005$  in.).
- 8.3 *Cylinder Liner, Piston, and Piston Ring Assembly*
- 8.3.1 *Cylinder Liner Fitting*  
For proper heat transfer, fit cylinder liners to the block according to the procedure outlined in the Mack Service Manual<sup>14</sup>.
- 8.3.2 *Piston and Rings*  
Cylinder liners, pistons, and rings are provided as a set and should be used as a set. Examine piston rings for any handling damage. Record pre-test measurements as detailed in Section 11.1.
- 8.4 *Injectors and Injection Pumps*
- 8.4.1 *Injectors*



Injector nozzles are available from the supplier shown in A2.2, Annex A2. Check the injector opening pressure at the start of each calibration period. Reset the injector opening pressure if it is outside the specification of 24,000 + 2000 kPa (3480 + 290 psi).

#### 8.4.2 *Injection Pumps*

The electronic unit pumps (EUP) may be changed at any time using the procedure specified in the Mack Service Manual. Be sure to enter the EUP's four digit calibration code into the Engine Control Unit (ECU). The calibration code can be found on the EUP label.

#### 8.5 *Assembly Instructions*

##### 8.5.1 *General*

The test parts specified for this test are intended to be used without material or dimensional modification. Exceptions, for example, a temporary parts supply problem, shall be approved by the Test Monitoring Center (TMC), and noted in the test report. All replacement test engine parts shall be genuine Mack Truck Inc. parts. Assemble all parts as illustrated in the Mack Service Manual except where otherwise noted. Target all dimensions for the means of the specifications. Use Bulldog Oil for lubricating parts during assembly; see A2.10, Annex A2.

##### 8.5.1.1 *Thermostat*

Block the thermostat wide open.

##### 8.5.1.2 *Connecting Rod Bearings*

Install new conrod bearings for each test. See Section 10.1 for pre-test measurements to be recorded.

##### 8.5.1.3 *Main Bearings*

Install new main bearings for each test.

##### 8.5.1.4 *Piston Undercrown Cooling Nozzles*

Particular care shall be taken in assembling the piston undercrown cooling nozzles to insure proper piston cooling (as outlined in the Mack Service Manual).

**NOTE 1:** Proper oil pressure is also important to assure sufficient oil volume for proper cooling.

##### 8.5.1.5 *Thrust Washers*

Install new thrust washers for each test.

##### 8.5.2 *New Parts*

Use test parts on a first-in/first-out basis. Install the following new parts for each rebuild, see Table A2.1, Annex A2 for part numbers:

8.5.2.1 Cylinder liners

8.5.2.2 Pistons

8.5.2.3 Piston rings

8.5.2.4 Overhaul gasket set

8.5.2.5 Oil filters

8.5.2.6 Engine coolant conditioner

8.5.2.7 Primary fuel filter

8.5.2.8 Secondary fuel filter

8.5.2.9 Valve stem seals

- 8.5.2.10 Valve guides
- 8.5.2.11 Connecting rod bearings
- 8.5.2.12 Main bearings
- 8.5.2.13 Thrust washers

## 8.6 *Measurements*

### 8.6.1 *Calibrations*

8.6.1.1 Calibrate thermocouples, pressure gages, speed and fuel flow measuring equipment prior to each reference oil test or at any time readout data indicates a need. Conduct calibrations with at least two points that bracket the normal operating range. Make these calibrations part of the laboratory record. During calibration, connect leads, hoses and read-out systems in the normally used manner and calibrate with necessary standards. For controlled temperatures, immerse thermocouples in calibration baths. Calibrate standards with instruments traceable to the National Institute of Standards and Technology on a yearly basis.

### 8.6.2 *Temperatures*

#### 8.6.2.1 *General*

Measure temperatures with thermocouples and conventional readout equipment or equivalent. For temperatures in the 0 - 150 °C (32 - 300 °F) range, calibrate temperature measuring systems to  $\pm 0.5$  °C for at least two temperatures that bracket the normal operating range. Insert all thermocouples so that the tips are located midstream of the flow unless otherwise indicated.

#### 8.6.2.2 *Ambient Air*

Locate thermocouple in a convenient, well-ventilated position from the engine and hot accessories.

#### 8.6.2.3 *Coolant*

Locate the coolant-out thermocouple in the water manifold prior to the thermostat housing. Locate in center of water stream. Refer to Fig. A1.6, Annex A1. Locate the coolant-in thermocouple anywhere between the heat exchanger and the coolant pump inlet. Refer to Fig. A1.7, Annex A1. → New picture needed.

#### 8.6.2.4 *Oil Gallery*

Locate thermocouple at the center port on the filter housing. Insertion depth shall be 98 mm (3.875 in.) Refer to Fig. A1.8, Annex A1.

#### 8.6.2.5 *Oil Sump Temperature*

Using a front sump oil pan configuration, locate thermocouple on the exhaust side of the oil pan, 178 mm (7 in.) from the front and 178 mm (7 in.) from the top of the pan. Thermocouple length shall be 4in. Refer to Fig. A1.4, Annex A1.

#### 8.6.2.6 *Intake Air Temperature*

Locate the intake air thermocouple in center of air stream at the turbocharger inlet as shown in Fig. A1.9, Annex A1. The temperature thermocouple is to be approximately 102 mm (4 in.) upstream of the compressor inlet connection. It is not necessary to control intake air humidity, but measurements are required.

- 8.6.2.7 *Fuel In*  
Locate thermocouple at the fitting on the outlet side of the fuel transfer pump as shown in Fig. A1.10, Annex A1.
- 8.6.2.8 *Pre-Turbine Exhaust*  
Locate one thermocouple in each side of exhaust manifold section, see Fig. A1.11, Annex A1.
- 8.6.2.9 *Exhaust Tailpipe*  
Locate thermocouple in exhaust pipe downstream of turbine according to Fig. A1.12, Annex A1.
- 8.6.2.10 *Intake Manifold*  
Locate thermocouple at tapped fitting on intake air manifold as shown in Fig. A1.13, Annex A1.
- 8.6.2.11 *EGR Cooler Inlet*  
Distinct EGR cooler inlet temperature measurements are not necessary. The pre-turbine exhaust temperatures may be used instead (refer to Section 8.6.2.8).
- 8.6.2.12 *EGR Cooler Outlet*  
Locate thermocouples as shown in Fig A1.14, Annex A1.
- 8.6.2.13 *EGR Pre-Venturi*  
Locate thermocouple as shown in Fig. A1.15, Annex A1 → new picture needed. Note, the EGR Pre-Venturi thermocouple shall be downstream of the pressure sensor.
- 8.6.2.14 *Additional*  
Monitor any additional temperatures that the test lab regards as helpful in providing a consistent test procedure.
- 8.6.3 *Pressures*
- 8.6.3.1 *Before Oil Filter*  
Locate pickup at tapped hole on oil cooler fitting, see Fig. A1.16, Annex A1.
- 8.6.3.2 *After Oil Filter (Main Oil Gallery)*  
Locate pickup at the left port of the filter housing. Refer to Fig. A1.8, Annex A1.
- 8.6.3.3 *Pre-Turbine Exhaust*  
Locate pickup in each side of exhaust manifold section, see Fig. A1.11, Annex A1. This measurement is not mandatory, but it is recommended for diagnostic and safety purposes.
- 8.6.3.4 *Intake Manifold (Air Boost)*  
Take measurement at tapped fitting provided on intake manifold as illustrated in Fig. A1.17, Annex A1
- 8.6.3.5 *Intake Air Pressure (Intake Air Restriction)*  
Measure with a Keil Probe (p/n KDF-8-W required) located approximately 203 mm (8 in.) upstream of the compressor inlet (see Fig. A1.9, Annex A1). The probes may be obtained from the supplier shown in A2.11.

- 8.6.3.6 *Exhaust Back*  
Locate pickup in exhaust pipe after turbocharger in center of exhaust stream. Measure exhaust back pressure in a straight section of pipe, 30.5 - 40.6 cm (12 - 16 in.) downstream of the turbo with a pressure tap hole as shown in Fig. A1.12, Annex A1.
- 8.6.3.7 *Crankcase Pressure*  
Locate pickup at any location in the auxiliary oil system vent line, such as between the dipstick tube fitting and the top of the auxiliary oil sump bucket.
- 8.6.3.8 *Compressor Discharge*  
Locate pickup within 15.2 cm (6 in.) of the second compressor.
- 8.6.3.9 *Coolant System*  
Locate pickup at the top of the coolant system expansion tank.
- 8.6.3.10 *Barometric Pressure*  
Locate barometer in a convenient location in the lab.
- 8.6.4 *Intake Carbon Dioxide Probe*  
Measure intake CO<sub>2</sub>. Locate the probe as shown in Fig. A1.8, Annex A1.
- 8.6.5 *Exhaust Carbon Dioxide Probe*  
Measure exhaust CO<sub>2</sub>. Locate the probe as shown in Fig. A1.12, Annex A1.
- 8.6.6 *Engine Blowby*  
Connect the metering instrument to the filter element canister on the engine front cover.
- 8.6.7 *Fuel Consumption Measurements*  
Place the measuring equipment in the fuel line before the primary fuel filter. Install the primary fuel filter before the fuel transfer pump and install the secondary filter before the unit injection pumps. *Fuel return lines shall never be plugged. Accurate fuel consumption measurements require proper accounting of return fuel.*
- 8.6.8 *Humidity*  
Place the measurement equipment downstream of any air conditioning and in such a manner as not to affect intake air temperature and pressure measurements.
- 8.7 *System Time Responses*  
The maximum allowable system time responses are shown in Table 2. Determine system time responses in accordance with the Data Acquisition and Control Automation II (DACA II) Task Force Report<sup>15</sup>.

**TABLE 2**  
**MAXIMUM ALLOWABLE SYSTEM TIME RESPONSES**

Measurement Type	Time Response (s)
Speed	2.0
Temperature	3.0
Pressure	3.0
Flow	45.0

## 9. PROCEDURE

### 9.1 *Pretest Procedure*

- 9.1.1 *Initial Oil Fill for Pretest Break-In*  
The initial oil fill is 32.7 kg (72.0 lb) of test oil. Add the first 3.3 kg (7.2 lb) of fresh test oil to the oil filters (half in each filter), then turn on the auxiliary oil pumps and add an additional 29.4 kg (64.8 lb) of test oil to the engine. This oil may be added directly through the engine oil fill tube.
- 9.1.2 *Pretest Break-In*
- 9.1.2.1 Run the break-in sequence described in Annex A5.
- 9.1.2.2 Drain the oil within 1 h after the break-in is completed. Replace all oil filters. Refill the engine with test oil and conduct the test in accordance with Section 9.4. When performing the pre-test oil charge, do not account for any hang up oil left in the oil system.
- 9.2 *Engine Start-Up*
- 9.2.1 Perform all engine start-ups according to Annex A5. Start-ups are not included as test time. Test time starts as soon as the engine returns to the test cycle. The start date and time of a test is defined as when the engine first reaches test conditions as shown in Table 3. **Warning** – Crank the engine prior to start-up to fill the engine oil passages. This practice will enhance engine durability significantly.
- 9.3 *Engine Shutdown*
- 9.3.1 Perform all non-emergency shutdowns according to Annex A5. The shutdown operation does not count as test time. Record the length and reason of each shutdown on the appropriate form.
- 9.3.2 All operationally valid tests should not exceed 10 shutdowns. Additionally, all operationally valid tests should not exceed 150 h of downtime. Conduct an engineering review if either condition is exceeded.
- 9.4 *Test Cycle*
- 9.4.1 The test cycle includes a 1-h break-in followed by a 300-h test. Operating conditions are shown in Table 2. Conduct the break-in by operating at Phase II conditions for 30 min, followed by Phase I conditions for 30 min. Conduct the test by operating for 100 h at Phase I conditions, followed 200 h at Phase II conditions. Conduct the transition from Phase I to Phase II according to Annex A5.
- 9.4.1.1 Based upon oil analysis, injection timing may be changed within the first 100 h of the test (Phase I) to ensure meeting the 100-h soot window of  $4.30\% \pm 0.30\%$  (refer to Section 11.7).
- 9.4.2 *Operational Validity*
- 9.4.2.1 Determine operational validity according to Annex A3.

**TABLE 3  
TEST CONDITIONS**

	Limits
--	--------

Parameters	Phase I	Phase II
Time, h	100	200
Injection Timing, °BTDC	Variable	21
<b>CONTROLLED PARAMETERS<sup>A</sup></b>		
Speed, r/min	1800	1200
Fuel Flow, kg/h (lb/h)	59.2 (130.5)	63.5 (140.0)
Intake CO <sub>2</sub> Level, %	3.09 +/- 0.05	1.42 +/- 0.05
Exhaust CO <sub>2</sub> Level, %	9.25 +/- 0.15	9.93 +/- 0.15
Inlet Manifold Temp., °C (°F)	90 (175)	80 (175)
Coolant Out Temp., °C (°F)	66 (150)	108 (226)
Fuel In Temp., °C (°F)	40 (104)	40 (104)
Oil Gallery Temp., °C (°F)	88 (190)	116 (240)
Intake Air Temp., °C (°F)	25 (77)	25 (77)
<b>RANGED PARAMETERS<sup>B</sup></b>		
Inlet Air Restriction, kPa (in. H <sub>2</sub> O)	3.5 – 4.0 (14 - 16)	3.5 - 4.0 (14 – 16)
Inlet Manifold Pressure, kPa (in. Hg)	Tbd	Tbd
Exhaust Back Pressure, kPa (in. H <sub>2</sub> O)	2.7 – 3.5 (11 - 14)	2.7 – 3.5 (11 – 14)
Crankcase Pressure, kPa (in. H <sub>2</sub> O)	0.25 – 0.75 (1 – 3)	0.25 – 0.75 (1 – 3)
<b>UNCONTROLLED PARAMETERS</b>		
Torque, N•m (lbf•ft) <sup>C</sup>	Record	Record
Exhaust Temp., °C (°F)		
Pre-turbine	Record	Record
Tailpipe	Record	Record
Oil Sump Temp., °C (°F)	Record	Record
Coolant In Temp., °C (°F)	Record	Record
EGR Pre-Venturi Temp., °C (°F)	Minimum 104 (220)	Minimum 104 (220)
Intercooler Out Temp., °C (°F)	Minimum 30 (86)	Minimum 30 (86)
Inlet Air Dew Point, °C (°F)	Record	Record
Inlet Air Humidity, g/kg (gr/lb)	Record	Record
Blowby, L/min (ft <sup>3</sup> /min)	Record	Record
EGR Pre-Venturi Pressure, kPa (in. Hg)	Record	Record
Pre-turbine Exhaust Pressure, kPa (in. Hg)	Record	Record
Main Gallery Oil Pressure, kPa (psi)	Record	Record
Oil Filter ΔP, kPa (psi)	Not to exceed 138 (20) <sup>D</sup>	Not to exceed 138 (20) <sup>D</sup>

A: All control parameters shall be targeted at the mean indicated.

B: All ranged parameters shall fall within the specified ranges.

C: At 98.2 kPa (29 in. Hg) and 29.5 °C (85 °F) dry air.

D: If oil filter ΔP exceeds 138 kPa (20 psi), change the two full flow filters. If the filters are changed, attempt to recover as much oil as possible by draining the filters. No new oil is to be added. The test report shall indicate if the filters are changed.

## 9.5 Oil Samples

9.5.1 Take 120-mL (4-oz) oil samples at every 25-h interval. Take the EOT oil sample within 30 min of test completion. Always take oil samples before new oil is added. Obtain oil samples from the pre-filter pressure port, refer to Fig. A1.16, Annex A1. This can be done by installing a tee fitting, a small petcock valve and 254 to 305 mm (10 to 12 in) of No. 4 Aeroquip line from which the sample is taken. Prior to each sample, take a 240-ml (8-oz) purge. After sampling has been completed, be sure to return the purge to the engine.

## 9.6 Oil Addition / Drain

9.6.1 Initially establish the Phase I full mark as the oil weight after 4 h of running at Phase I test conditions, but *do not* add any new oil until 100 test h (Phase II). Before transitioning to Phase II record the oil weight. Drain a sufficient amount of oil to obtain an oil weight which is 2.27 kg (5.0 lb) below the Phase I full mark, and add 2.27 kg (5.0 lb) of new oil to the engine. If the oil weight is already more than 2.27 kg (5.0 lb) below the full mark, do not perform a forced drain.

- 9.6.1.1 At 104 h establish the Phase II full mark. Starting at 150 h and each 50-h period thereafter, drain a sufficient amount of oil to obtain an oil weight which is 2.27 kg (5.0 lb) below the full mark, and add 2.27 kg (5.0 lb) of new oil to the engine. For any 50-h period, if the oil weight is already more than 2.27 kg (5.0 lb) below the full mark, do not perform a forced drain.
- 9.7 *Oil Weight Measurements*
- 9.7.1 Record the oil weight every 6 min and compute the oil consumption (refer to Section 10.5) from these readings.
- 9.8 *Fuel Samples*
- 9.8.1 Take fuel samples (two 1-L [1-qt] samples) prior to the start of test and at EOT.
- 9.9 *Periodic Measurements*
- 9.9.1 Make measurements at 6 min intervals on the parameters listed in Section 9.9.2 and record statistics on the appropriate form. Automatic data acquisition is required. Recorded values shall have minimum resolution as shown in Table 4. Characterize the procedure used to calculate the data averages on the appropriate form.

**TABLE 4  
MINIMUM RESOLUTION OF RECORDED MEASUREMENTS**

PARAMETER	Record Data to Nearest	PARAMETER	Record Data to Nearest
Speed	1 r/min	Blowby	1 L/min
Fuel Flow	0.1 kg/h	Inlet Air Dew Point	1 °C
Coolant Temperatures	0.1 °C	Oil Temperatures	0.1 °C
Fuel In Temperature	0.1 °C	Exhaust Temperatures	1 °C
Intake Air Temperature	0.1 °C	EGR Temperatures	1 °C
Intake Manifold Temperature	0.1 °C	Oil Pressures	1 kPa
Exhaust Back Pressure	0.1 kPa	Crankcase Pressure	0.1 kPa
Inlet Air Restriction	0.1 kPa	Intake Manifold Pressure	1 kPa
Torque	1 N•m	Intake and Exhaust CO <sub>2</sub>	0.01 %
Power	1 kW	Oil Weight	0.001 kg
Humidity	0.1 g/kg		

- 9.9.2 Parameters
- 9.9.2.1 Speed, r/min
- 9.9.2.2 Torque, N•m (lb•ft)
- 9.9.2.3 Oil Gallery Temperature, °C (°F)
- 9.9.2.4 Oil Sump Temperature, °C (°F)
- 9.9.2.5 Coolant Out Temperature, °C (°F)
- 9.9.2.6 Coolant In Temperature, °C (°F)
- 9.9.2.7 Intake Air Temperature, °C (°F)
- 9.9.2.8 Intake Manifold Temperature, °C (°F)
- 9.9.2.9 Intake Manifold Pressure, kPa (in. Hg)
- 9.9.2.10 Fuel Flow, s/kg or kg/h (s/lb or lb/h)
- 9.9.2.11 Fuel Inlet Temperature, °C (°F)
- 9.9.2.12 Tailpipe Exhaust Back Pressure, kPa (in. H<sub>2</sub>O)
- 9.9.2.13 Before Filter Oil Pressure, kPa (psi)
- 9.9.2.14 Main Gallery Oil Pressure, kPa (psi)
- 9.9.2.15 Crankcase Pressure, kPa (in. H<sub>2</sub>O)
- 9.9.2.16 Pre-Turbine Exhaust Temperature, Front Manifold, °C (°F)

- 9.9.2.17 Pre-Turbine Exhaust Temperature, Rear Manifold, °C (°F)
- 9.9.2.18 Inlet Air Restriction, kPa (in. H<sub>2</sub>O)
- 9.9.2.19 Tailpipe Exhaust Temperature, °C (°F)
- 9.9.2.20 Crankcase Blowby, L/min (ft<sup>3</sup>/min) (see Section 9.10)
- 9.9.2.21 Pre-Turbine Exhaust Pressure, Front Manifold, kPa (in. Hg)
- 9.9.2.22 Pre-Turbine Exhaust Pressure, Rear Manifold, kPa (in. Hg)
- 9.9.2.23 Inlet Air Humidity, g/kg (grains/lb)
- 9.9.2.24 EGR Cooler Outlet Temperature, °C (°F)
- 9.9.2.25 EGR Pre-Venturi Temperature, °C (°F)
- 9.9.2.26 Inlet Air Dew Point, °C (°F)
- 9.9.2.27 Oil Weight, kg (lbf)

9.10 *Blowby*  
Record the crankcase blowby on the appropriate form. Take care to prevent oil traps from occurring in the blowby line at any time during operation.

9.11 *Centrifugal Oil Filter Mass Gain*  
Prior to the start of test, determine the mass of the centrifugal oil filter canister. At EOT, remove the centrifugal oil filter canister from the engine and drain upside down for 30 min. After draining, determine the mass of the canister and record on the appropriate form. Determine the centrifugal oil filter mass gain for each test.

9.12 *Oil Filter ΔP Calculation*  
The reported oil filter ΔP is the maximum oil filter ΔP that occurs as a result of the test. Calculate the oil filter ΔP as follows:

$$\Delta P = \Delta P_{\max} - \Delta P_{\text{initial}} \quad (1)$$

where: ΔP<sub>max</sub> = the maximum ΔP across the oil filter.

ΔP<sub>initial</sub> = the ΔP across the oil filter at the start of test conditions.

If an oil filter change is made, add the oil filter ΔP value obtained after the filter change to the oil filter ΔP obtained prior to the filter change. If a shutdown occurs, add the oil filter ΔP value obtained after the shutdown to the oil filter ΔP obtained prior to the shutdown. Change the oil filter if the ΔP exceeds 138 kPa (20 psi). Report oil filter ΔP on the appropriate form.

9.13 *Carbon Dioxide*  
Measure and record intake and exhaust CO<sub>2</sub> levels every 4 h.

## 10. INSPECTION OF ENGINE, FUEL, AND OIL

10.1 *Pre-Test Measurements*

10.1.1 *Pistons*

10.1.1.1 No piston measurements are required.

10.1.2 *Cylinder Sleeves Inside Diameter Surface Finish* – Measurement is to be an average of four readings, taken at 90° intervals over a 12.7-mm (0.50-in.) axial trace length,



beginning at 6.35 mm (0.25 in.) from the top of the sleeve and extending to 19.1 mm (0.75 in.) from the top of the sleeve. Identify these trace locations as 12 o'clock (12:00), 3 o'clock (3:00), 6 o'clock (6:00), and 9 o'clock (9:00). For reference, locate 12:00 towards the front of engine. Designate the cylinder number equivalent permanent mark on the water jacket portion of the sleeve's outside diameter.

10.1.3 *Piston Rings* – Clean and measure according to the Mack Test Ring Cleaning and Measuring Procedure, available from the TMC. Report results on the appropriate form.

10.1.4 *Connecting Rod Bearings:*

10.1.4.1 Prior to measuring, mark bearings with a single digit on the locating tang to identify cylinder location.

10.1.4.2 Clean the bearings with solvent (see 7.4). Use a soft brush if necessary. Spray bearings dry with air. Rinse in pentane. Do not handle bearings with bare hands. Use gloves or plastic covered tongs.

10.1.4.3 Weigh bearings on a scale capable of a resolution of 1 mg.

10.2 *Post Test Engine Measurements*

10.2.1 *Pistons*

Before removing pistons, carefully remove carbon from top of cylinder sleeve - *do not remove any metal.*

10.2.1.1 Rate all six pistons for deposits according to Test Method D 6681. Use the 1P piston rating method. Report the results on the appropriate forms.

10.2.2 *Cylinder Sleeves* – Measure according to Instructions for Measuring Cylinder Sleeves, available from the TMC. Report the results on the appropriate form.

10.2.3 *Piston Rings* – Clean and measure according to the Mack Test Ring Cleaning and Measuring Procedure, available from the TMC. Report results on the appropriate form.

10.2.4 *Connecting Rod Bearings*

10.2.4.1 Clean the bearings with solvent (see 7.4). Use a soft brush if necessary. Spray bearings dry with air. Rinse in pentane. Do not handle bearings with bare hands. Use gloves or plastic covered tongs.

10.2.4.2 Weigh bearings on a scale capable of a resolution of 1 mg.

10.3 *Oil Inspection*

10.3.1 Analyze oil samples for viscosity at 100 °C (212 °F) according to either Test Method D 455 or Test Method D 5967, Annex A3. Base viscosity increase on the minimum viscosity. In addition to the viscosity measurements, conduct soot analysis according to Test Method D 5967, Annex A4. Conduct the 100-h soot measurement twice and report the average (round the result according to Practice E 29). To maintain accuracy and precision conduct all soot measurements at a TMC-calibrated laboratory. Determine wear metals content (iron, lead, copper, chromium, aluminum, nickel), additive metals content, silicon and sodium levels according to Test Method D 5185 every 25 h from 0 h to EOT.

Conduct EOT lead content measurements at least twice and report the average value. Conduct oil analysis as soon as possible after sampling. Determine base number every 25 h, including EOT, according to Test Method D 4739. Determine acid number every 25 h, including EOT, according to Test Method D 664. Determine oxidation using integrated IR every 25 h, including EOT. Report all results.

10.4 *Fuel Inspections*

10.4.1 Use fuel purchase inspection records to insure conformance to the specifications listed in Table 1 and to complete Form 12 for the last batch of fuel used during the test. In addition, perform the following inspections on new (0 h) and EOT (300 h) fuel samples:

API Gravity at 15.6 °C (60 °F), Test Method D 287 or D 4052  
 Total Sulfur, ppm converted to % Weight, Test Method D 129 or D 2622  
 Use one 1-L (1-qt) sample for inspections.

10.5 *Oil Consumption Calculation*

10.5.1 Using the 6 min oil weight measurements (Section 9.7), determine the oil consumption in g/h by performing linear regression on the data for each of the eight 25-h periods from 100 to 300 h. The oil consumption for a 25-h period is the slope of the regression line for that same period. The reported oil consumption is the average of the eight results.

10.5.1.1 Following any shutdowns, oil samples, oil additions, or phase transitions exclude 1 h of oil weight data from the regression to account for the stabilizing of the oil scale.

10.5.1.2 If any shutdowns occur during a 25-h period, the result for that 25-h period shall be the weighted average of all the regression slopes that apply to that period. The weighting of a regression slopes is the length of run time associated with it. An example with two shutdowns, one at 109 h and one at 118.5 h is shown below:

**25-h Period Oil Consumption Sample Calculation**

Oil Scale Data	Time Start (hh:mm)	Time Stop (hh:mm)	Run Time	Regression Slope (g/h)
Stabilizing	100:00	101:00	1:00	n/a
Collecting	101:00	109:00	<b>8:00</b>	<b>40.0</b>
Stabilizing	109:00	110:00	1:00	n/a
Collecting	110:00	118:30	<b>8:30</b>	<b>45.0</b>
Stabilizing	118:30	119:30	1:00	n/a
Collecting	119:30	125:00	<b>5:30</b>	<b>48.5</b>
Oil Consumption 75 – 100 h = [(8 x 40.0) + (8.5 x 45.0) + (5.5 x 48.5)] / 22 = <b>44.1 g/h</b>				

10.5.1.3 Report the average oil consumption for the test on the appropriate form.

**11. Laboratory and Engine Test Stand Calibration / Non-Reference Requirements**

11.1 *Calibration Frequency*

11.1.1 To maintain test consistency and severity levels, calibrate the test stand at regular intervals.

11.2 *Calibration Reference Oils*

11.2.1 The reference oils used to calibrate T-12 test stands have been formulated or selected to represent specific chemical types or performance levels, or both. They can be obtained from the TMC. The TMC will assign reference oils for calibration tests. These oils are supplied under code numbers (blind reference oils).

#### 11.2.2 *Reference Oils Analysis*

11.2.2.1 Do not submit reference oils to physical or chemical analyses for identification purposes. Identifying the oils by analyses could undermine the confidentiality required to operate an effective blind reference oil system. Therefore, reference oils are supplied with the explicit understanding that they will not be subjected to analyses other than those specified within this procedure unless specifically authorized by the TMC. In such cases where analyses are authorized, supply written confirmation of the circumstances involved, the data obtained, and the name of the person authorizing the analysis to the TMC.

#### 11.3 *Test Numbering*

11.3.1 Number each T-12 test to identify the test stand number, the test stand run number, engine serial number, and engine hours at the start of the test. The sequential stand run number remains unchanged for reruns of aborted, invalid, or unacceptable calibration tests. However, follow the sequential stand run number by the letter A for the first rerun, B for the second, and so forth. For calibration tests, engine hours shall be zero. For non-reference oil tests, engine hours are the test hours accumulated since last calibration. For example, 58-12A-2H0380-0 defines a test on stand 58 and stand run 12 as a calibration test that was run twice on engine 2H0380 (serial number). A test number of 58-14-2H0380-300 defines a test on stand 58 and stand run 14 as a non-reference oil test on engine 2H0380, which has run 300 hours since the last reference.

#### 11.4 *New Laboratories and New Test Stands*

11.4.1 A new lab is any lab that has never previously calibrated a test stand under this test method, or has not calibrated a test stand within one year from the end of the last successful calibration test. All stands at a new laboratory are considered new stands.

11.4.2 A new stand is a test cell and support hardware which has never previously been calibrated under this test method, or has not been calibrated within a year from the end of the last successful calibration test on that stand.

11.4.2.1 A new complete engine with EGR kit requires a successful calibration test.

11.4.3 Calibrate a new test stand in accordance with the Lubricant Test Monitoring System (LTMS)<sup>13</sup>.

#### 11.5 *Test Stand Calibration*

11.5.1 *Test Stand Calibration* – Perform a calibration test on a reference oil assigned by the TMC after six months have elapsed since the completion of the last successful calibration test. A non-reference test may be started provided at least one h remains in the calibration period. An unsuccessful calibration test voids any current calibration on the test stand.

11.5.2 *Test Stand / Engine Combination* – For reference and non-reference tests, any engine may be used in any stand. However, the engines shall be used in the test stands on a first

available engine basis (FIFO). In other words, there shall be no attempt on the part of the test laboratory to match a particular test stand and engine combination for any given test.

- 11.5.2.1 A new complete engine setup with EGR kit requires a calibration test.
- 11.5.3 If non-standard tests are conducted on a calibrated test stand, the TMC may require the test stand to be recalibrated prior to running standard tests.
- 11.5.4 The TMC may shorten or extend calibrations at their discretion.

## 11.6 *Test Results*

- 11.6.1 The reference oil test specified test results are average top ring weight loss (mg), average cylinder liner wear ( $\mu\text{m}$ ),  $\Delta$  lead (mass ppm) at EOT,  $\Delta$  lead (mass ppm) 250 – 300 h, and average oil consumption (g/h). The non-reference oil test specified test result is the Mack Merit Rating.

### 11.6.2 *Average Top Ring Weight Loss*

- 11.6.2.1 Screen the data for outliers according to Annex A9. Calculate the average top ring weight loss, excluding any outliers, and report the data on the appropriate forms.

### 11.6.3 *Average Cylinder Liner Wear*

- 11.6.3.1 Screen the data for outliers according to Annex A9. Calculate the average cylinder liner wear step, excluding any outliers, and report the data on the appropriate forms.

### 11.6.4 *$\Delta$ Lead at EOT*

$\Delta$  Lead at EOT results are adjusted to account for any upper rod bearing weight loss outliers.

- 11.6.4.1 Calculate the measured average upper rod bearing weight loss and report the value on the appropriate form.

- 11.6.4.2 Use Practice E 178, two-sided test at a 95% significance level, to determine if any rod bearing weight loss values are outliers. Report the outlier screened average upper rod bearing weight loss on the appropriate form. If no outliers were identified, this value will be identical to the measured value calculated in section 11.6.4.1.1.

- 11.6.4.3 Calculate  $\Delta$  lead according to the following:

$$\Delta\text{lead} = (\text{lead}_{300} - \text{lead}_{\text{NEW}}) \times (\text{OABWLU} / \text{ABWLU}) \quad (2)$$

where:

$\text{lead}_{300}$  = lead content of the 300 h oil sample, ppm

$\text{lead}_{\text{NEW}}$  = lead content of the new oil sample, ppm

ABWLU = as measured upper rod bearing weight loss, mg

OABWLU = outlier screened upper rod bearing weight loss, mg

Report the calculated  $\Delta$  lead at EOT value on the appropriate forms.

### 11.6.5 *$\Delta$ Lead 250 – 300 h*

- 11.6.5.1 Calculate the  $\Delta$  Lead 250 – 300 h by subtracting the lead value at 250 h from the lead value at 300 h. Report the results on Forms 4 and 8. Do not adjust the results to account for outlier upper rod bearings.
- 11.6.6 *Oil Consumption*
- 11.6.6.1 Report the oil consumption, as calculated per section 10.5, on the appropriate form.
- 11.6.7 *Mack Merit Rating*
- 11.6.7.1 Report the Mack Merit Rating as calculated per Annex A10.
- 11.7 *Reference and Non-Reference Oil Test Requirements*
- 11.7.1 All operationally valid tests shall produce a TGA soot level of  $4.30 \pm 0.30$  % at 100 h. Any test which misses the 100-h soot window is considered operationally invalid. A lab should terminate a test that has missed the 100-h soot window.
- 11.7.1.1 Injection timing can be adjusted anytime within the first 100 h to meet the 100-h soot window. However, during the first 100 h do not adjust injection timing more than  $\pm 3^\circ$  from the initial injection timing.
- 11.7.2 Calibration acceptance is determined in accordance with the Lubricant Test Monitoring System<sup>16</sup> (LTMS) as administered by the TMC.
- 11.8 *Non-Reference Oil Test Result Severity Adjustments*
- 11.8.1 This test method incorporates the use of a Severity Adjustment (SA) for non-reference oil test results. A control chart technique, described in the LTMS, has been selected for identifying when a bias becomes significant for average top ring weight loss, average cylinder liner wear,  $\Delta$  lead at EOT,  $\Delta$  lead 250 – 300 h, and oil consumption. When calibration test results identify a significant bias, determine a SA according to LTMS. Report the SA value on Form 4, Test Results Summary, in the space for SA. Add this SA value to non-reference oil test results, and enter the adjusted result in the appropriate space. The SA remains in effect until a new SA is determined from subsequent calibration test results, or the test results indicate the bias is no longer significant. Calculate and apply SA's on a laboratory basis.

## 12. REPORT

- 12.1 *Reporting Reference Oil Test Results*
- For reference oil tests, the standardized report form set and data dictionary for reporting test results and for summarizing operational data are required. Report forms and the Data Dictionary are available from the TMC. Fill out the report forms according to the formats shown in the Data Dictionary. When transmitting data electronically, a Header Data Dictionary shall precede the Data Dictionary. The latest version of this Header Data Dictionary can be obtained from the TMC either by ftp (internet) or by calling the Test Engineer responsible for this particular test. Round the data in accordance with Practice E 29.
- 12.1.1 During the test, if the engine is shut down or operated out of test limits, record the test hours, time, and date on the appropriate form. In addition, all prior reference oil tests that

were deemed operationally or statistically invalid should be noted in the comment section.

- 12.1.2 When reporting reference oil test results, transmit the test data electronically by utilizing the ASTM Data Communications Committee Test Report Transmission Model (see Section 2 – Flat File Transmission Format) which is available from the TMC. Transmit the data within five working days of test completion. Mail a copy of the final test report within 30 days of test completion to:

ASTM Test Monitoring Center  
6555 Penn Avenue  
Pittsburgh, PA 15206-4489

- 12.2 *Deviations from Test Operational Limits*  
Report all deviations from specified test operational limits on Form 11 under Other Comments.

### 13. PRECISION AND BIAS

#### 13.1 *Precision*

- 13.1.1 Test precision is established on the basis of operationally valid reference oil test results monitored by the TMC. [Research Report RR:D02-XXXX<sup>17</sup>](#) contains industry data developed prior to establishment of this method.

- 13.1.1.1 *Intermediate Precision Conditions* – Conditions where test results are obtained with the same test method using the same test oil, with changing conditions such as operators, measuring equipment, test stands, test engines, and time.

**NOTE 2:** The Intermediate precision is the appropriate term for the method rather than repeatability which defines more rigorous within-laboratory conditions.

- 13.1.1.2 *Intermediate Precision Limit (i.p.)* – The difference between two results obtained under intermediate precision conditions that would, in the long run, in the normal and correct conduct of the test method, exceed the values shown in Table 4 in only one case in twenty. When only a single test result is available, the Intermediate Precision Limit can be used to calculate a range (test result  $\pm$  Intermediate Precision Limit) outside of which a second test result would be expected to fall about one time in twenty.

- 13.1.1.3 *Reproducibility Conditions* – Conditions where test results are obtained with the same test method using the same test oil in different laboratories with different operators using different equipment.

- 13.1.1.4 *Reproducibility Limit (R)* – The difference between two results obtained under reproducibility conditions that would, in the long run, in the normal and correct conduct of the test method, exceed the values shown in Table 4 in only one case in twenty. When only a single test result is available, the Intermediate Precision Limit can be used to calculate a range (test result  $\pm$  Reproducibility Limit) outside of which a second test result would be expected to fall about one time in twenty.

- 13.1.2 Test precision, as of [Month DD, YYYY](#) is shown in Table 5.

**TABLE 5**  
**Test Precision**

Measured Units		
Test Result	Intermediate Precision, (i.p.)	Reproducibility, (R)
Adjusted Liner Wear, $\mu\text{m}$ Top Ring Weight Loss, mg $\Delta\text{Pb}$ at EOT, ppm (transformed units) <sup>4</sup> Oil Consumption, g/h $\Delta$ Lead 250 – 300 h, ppm		

<sup>4</sup>This parameter is transformed using a natural log. When comparing two test results on this parameter, first apply this transformation to each test result. Compare the absolute difference between the transformed results with the appropriate (intermediate or reproducibility) precision limit.

13.1.3            The TMC will be able to update precision data as it becomes available.

13.2            *Bias*

Bias is determined by applying an accepted statistical technique to reference oil test results and when a significant bias is determined, a severity adjustment is permitted for non-reference oil test results (see Section 11.8).

**14.            KEYWORDS**

lubricants, diesel engine oil, T-12 Diesel Engine, top ring weight loss, cylinder liner wear, lead, oil consumption, oxidation, soot, exhaust gas recirculation, ultra-low sulfur diesel fuel

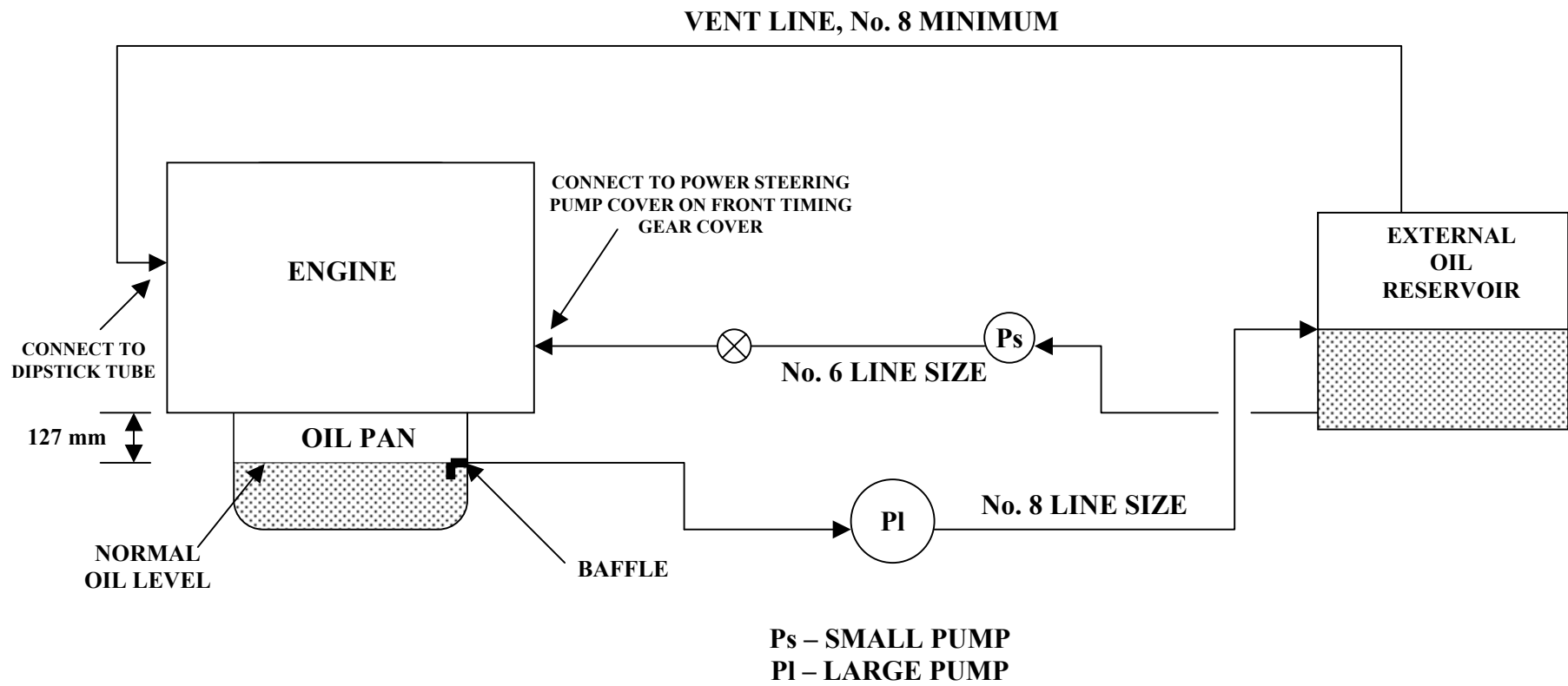




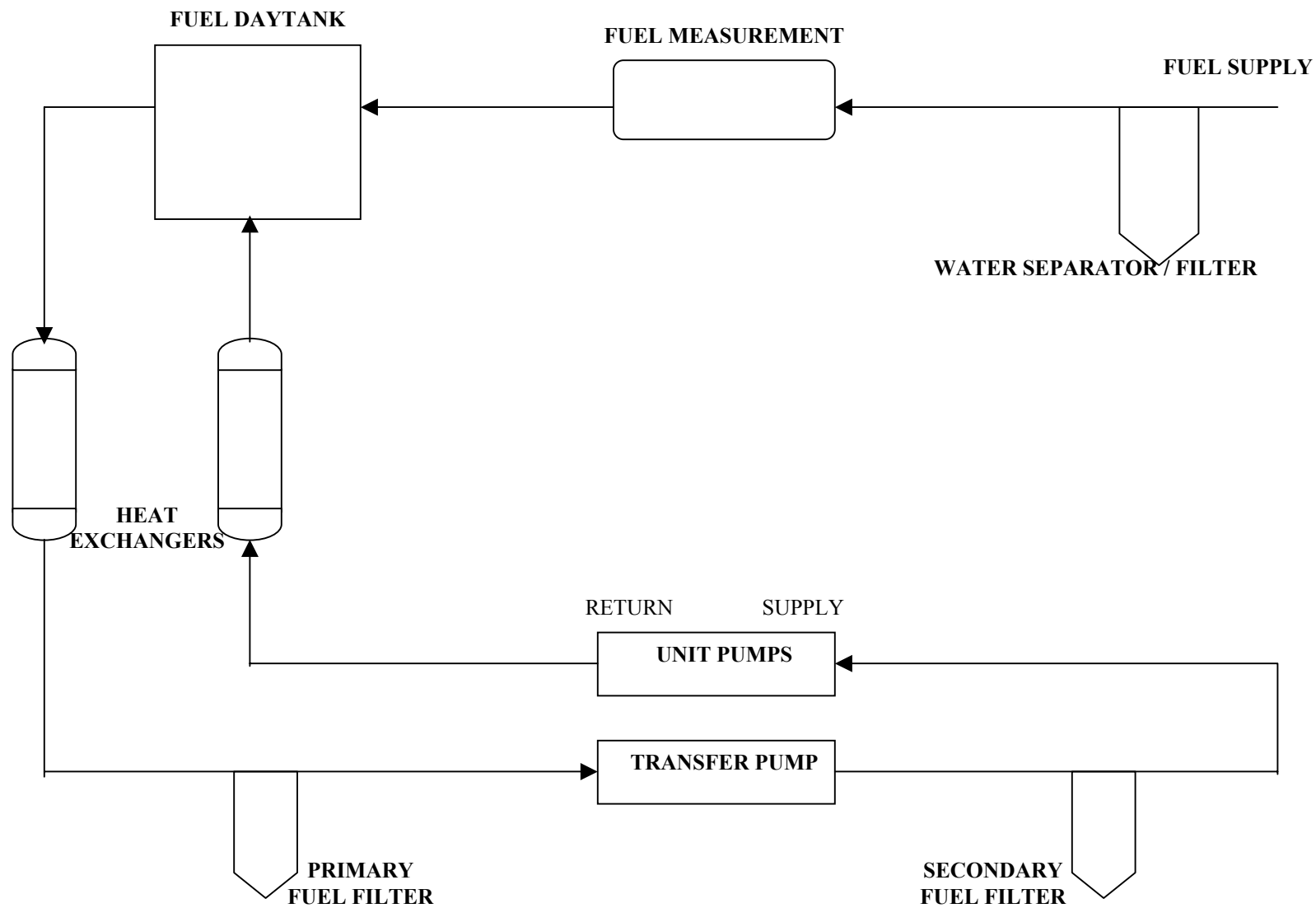
**ANNEXES**  
**(Mandatory Information)**

**A1. SYSTEM SCHEMATICS AND SENSOR LOCATIONS**

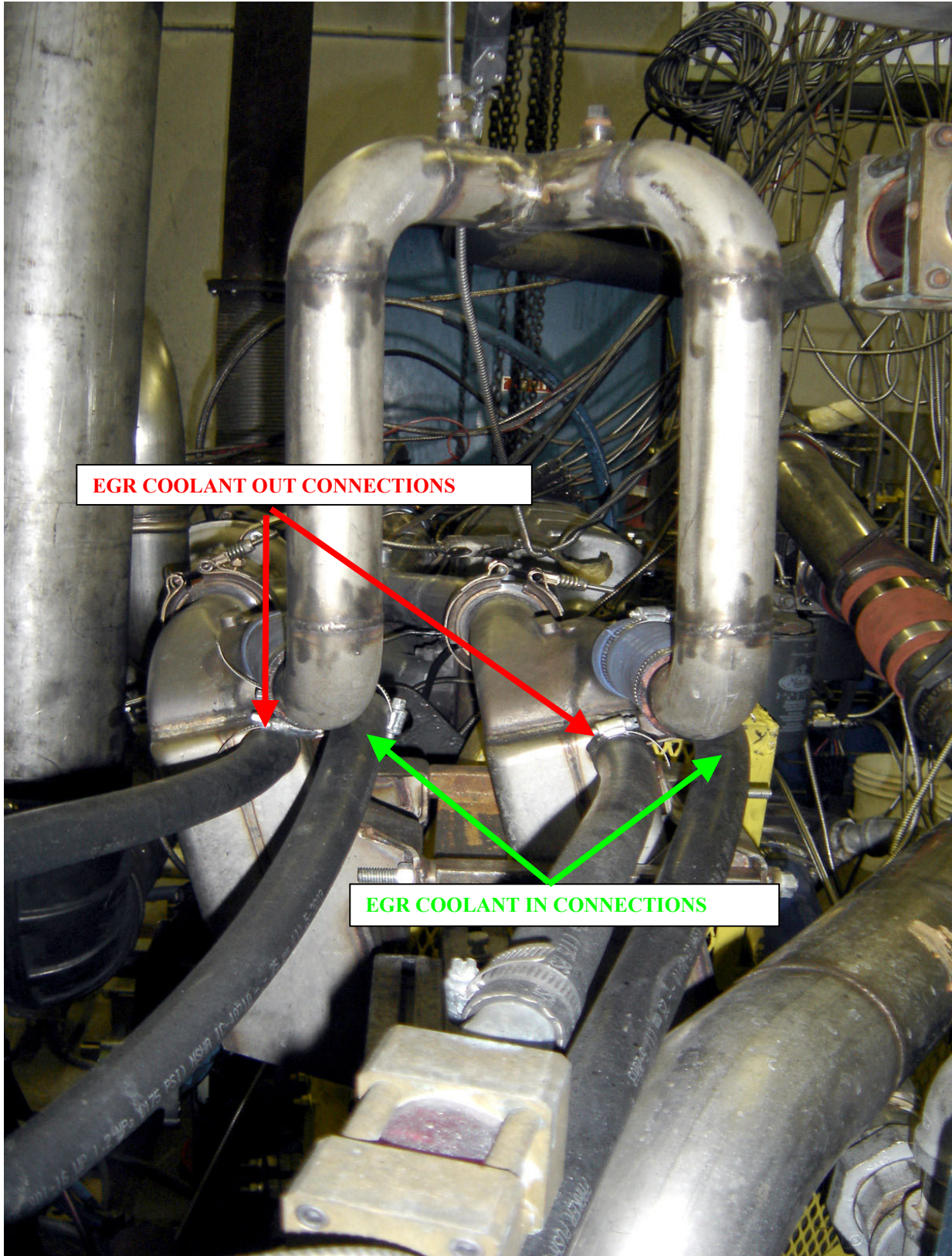
Properly locating the sensor devices is important to this test. The following figures indicate the sensor locations for the T-10 engine components.



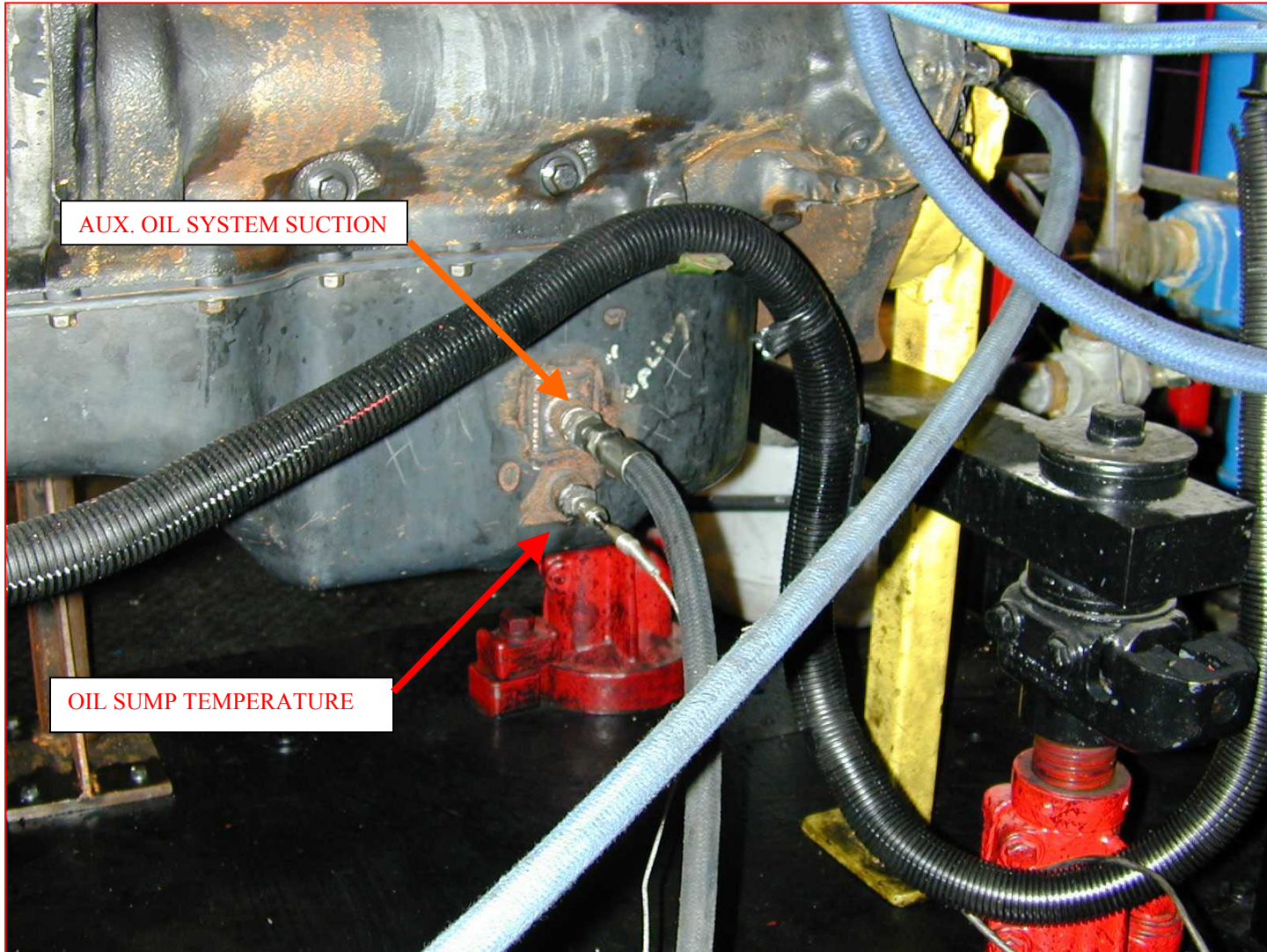
**FIG A1.1 AUXILIARY OIL SYSTEM**



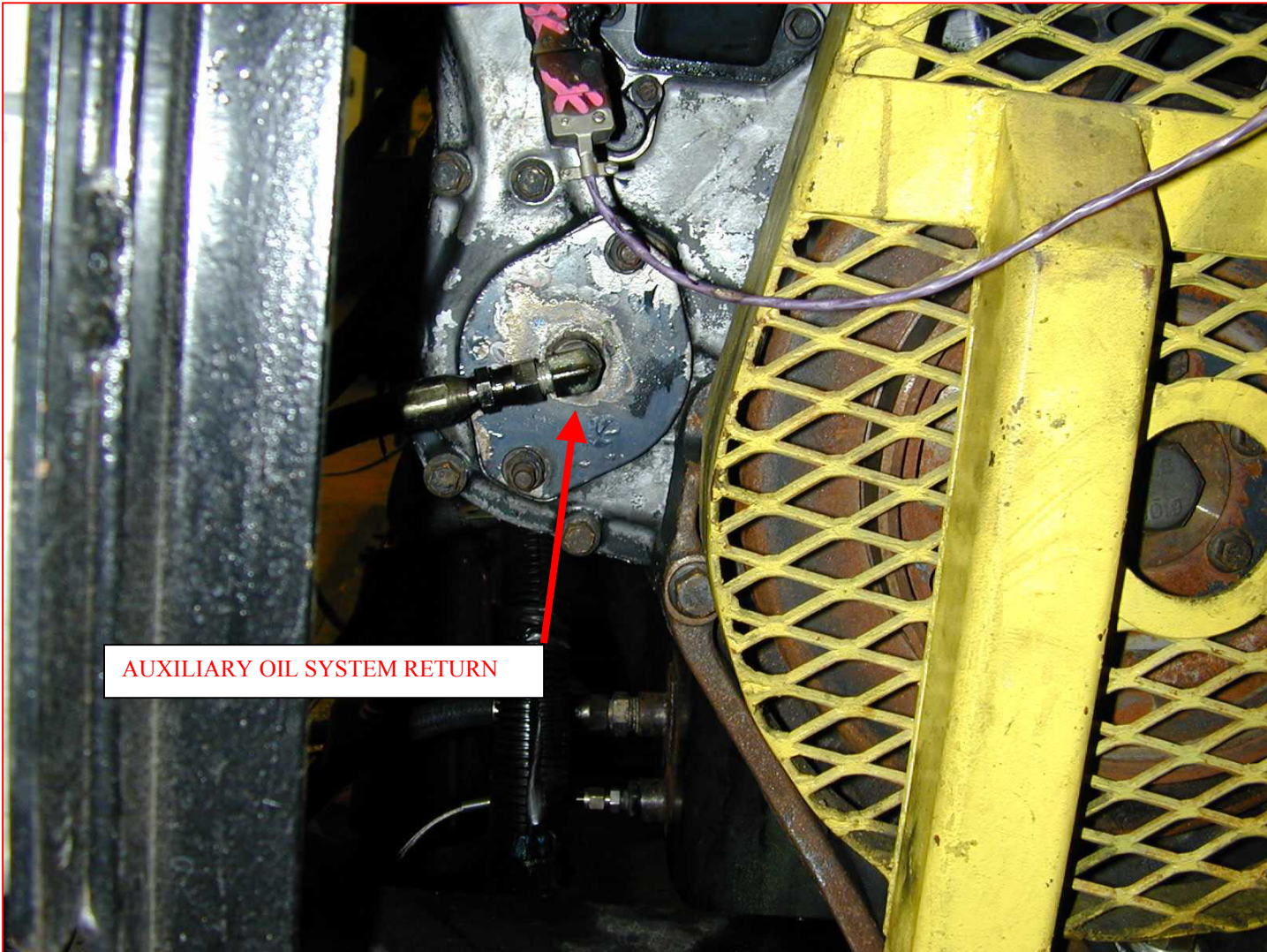
**FIG. A1.2 TEST CELL FUEL SCHEMATIC**



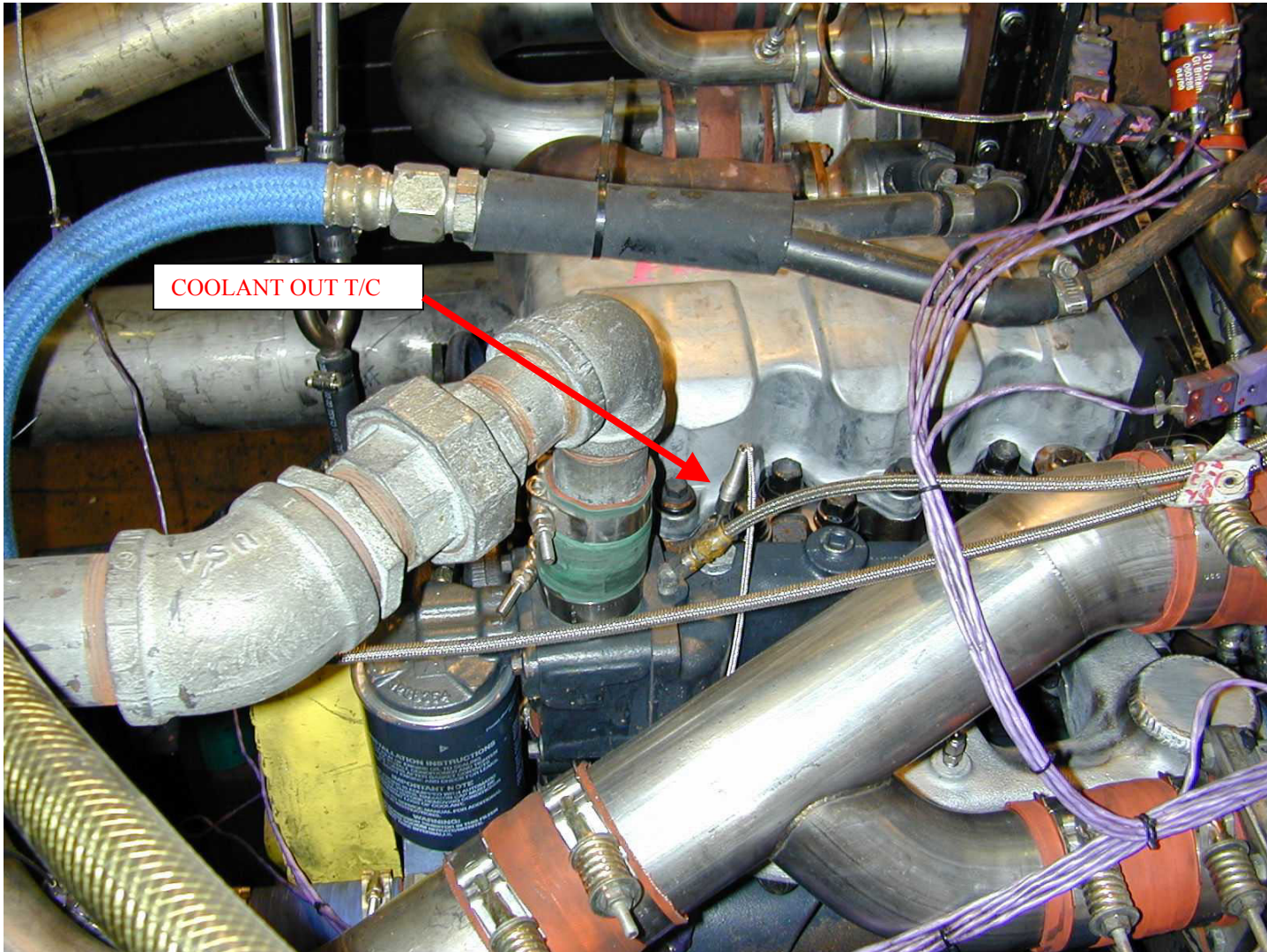
**FIG. A1.3 COOLANT SUPPLY TO EGR COOLER**



**FIG. A1.4 AUXILIARY OIL SYSTEM SUCTION LINE AND OIL SUMP TEMPERATURE THERMOCOUPLE**

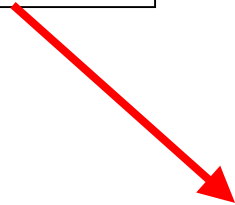


**FIG. A1.5 AUXILIARY OIL SYSTEM RETURN**



**FIG. A1.6 COOLANT OUT TEMPERATURE**

EGR COOLANT RETURN

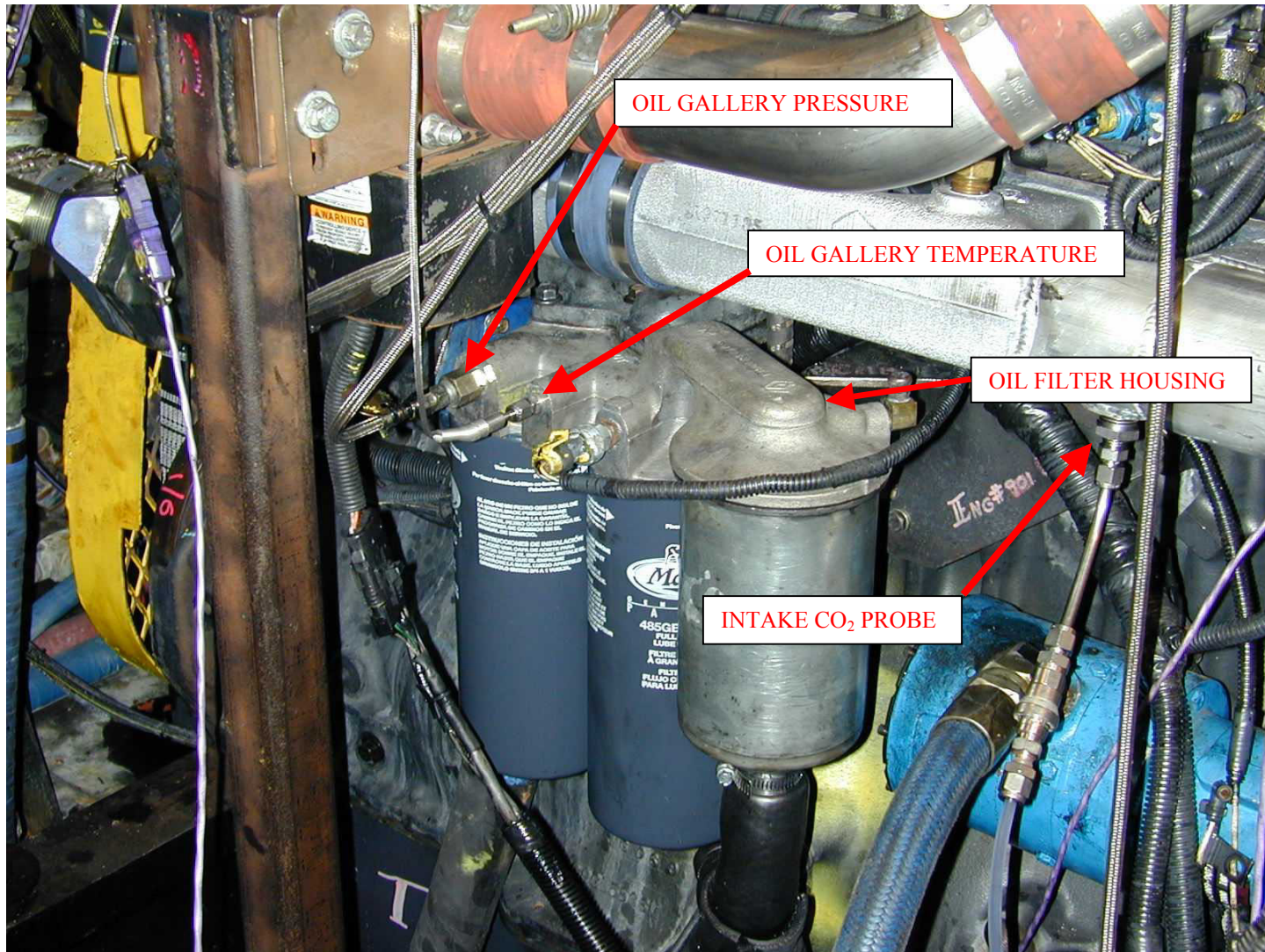


**FIG. A1.7 ENGINE COOLANT IN TEMPERATURE AND EGR COOLANT RETURN**

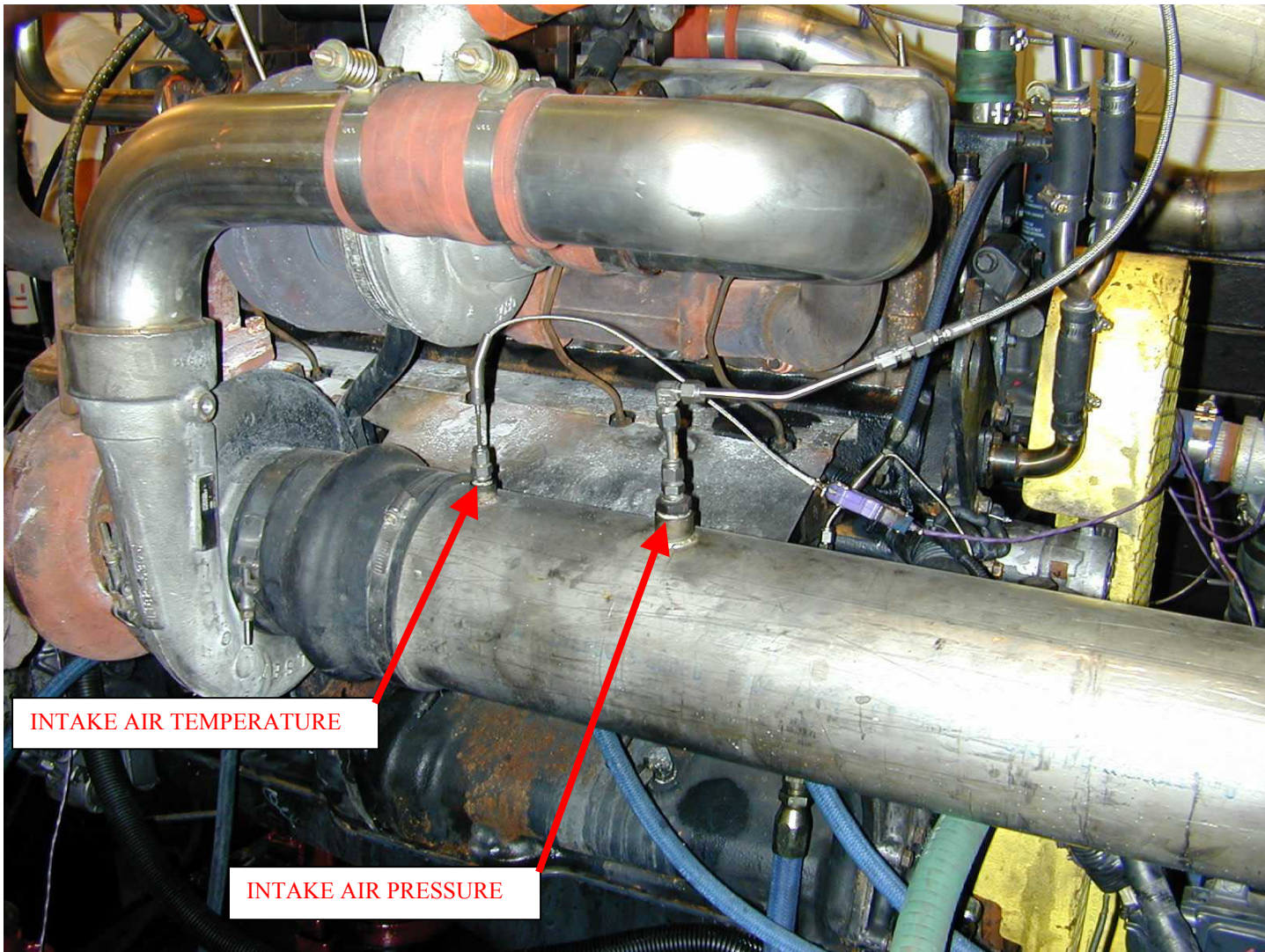
COOLANT IN T/C



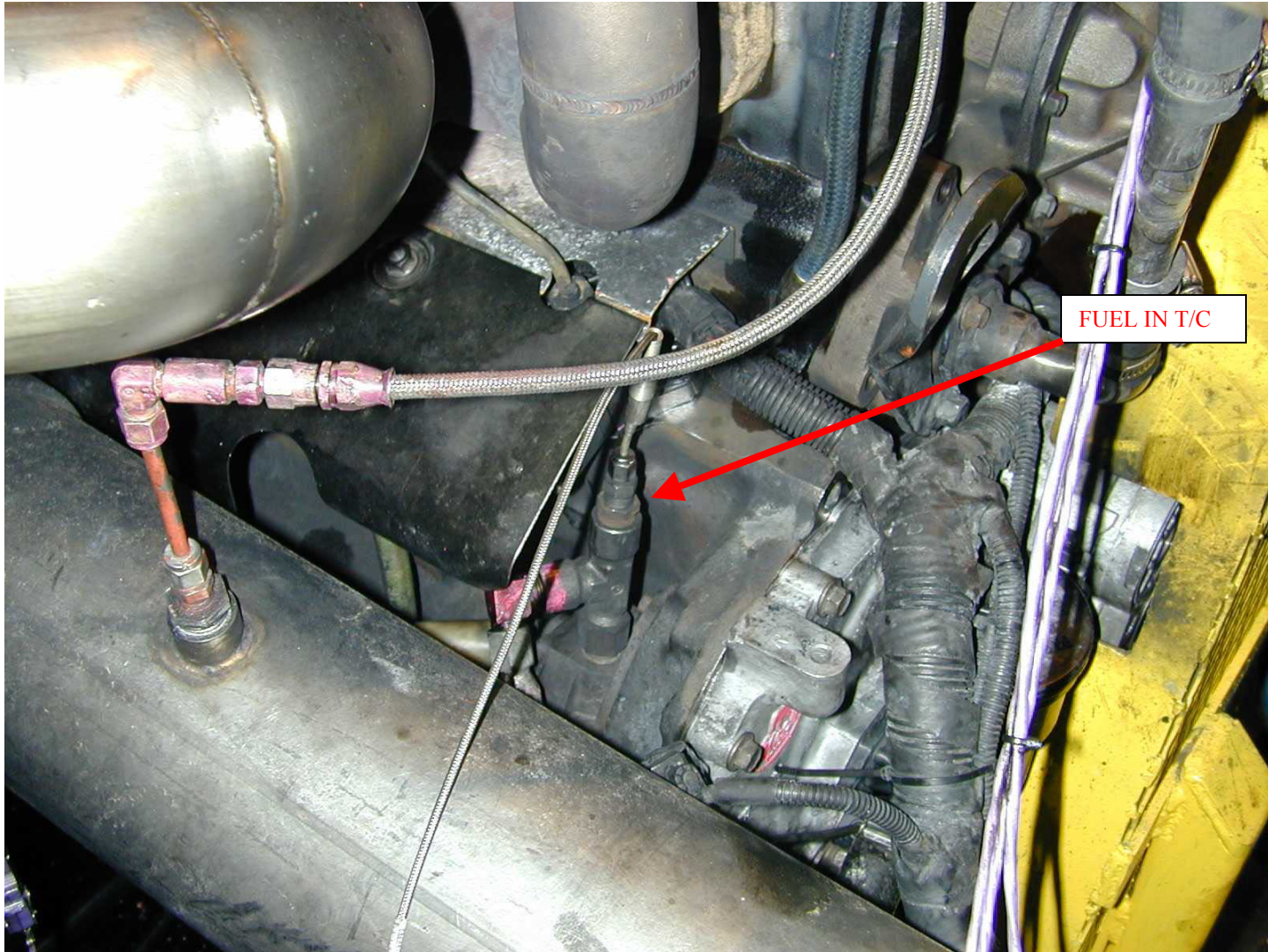




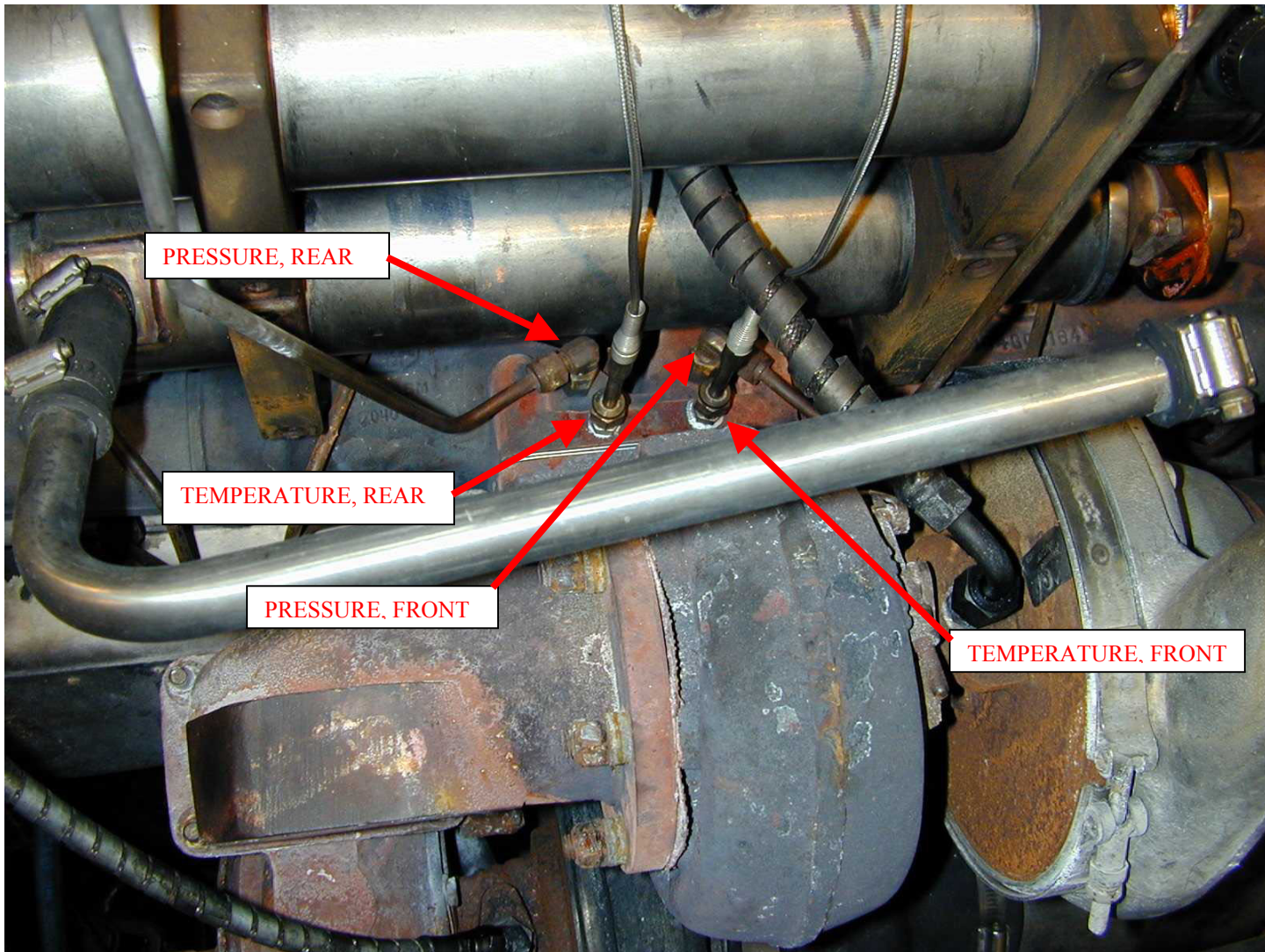
**FIG. A1.8 OIL GALLERY TEMPERATURE AND PRESSURE (AFTER-FILTER PRESSURE) AND INTAKE CO<sub>2</sub> PROBE**



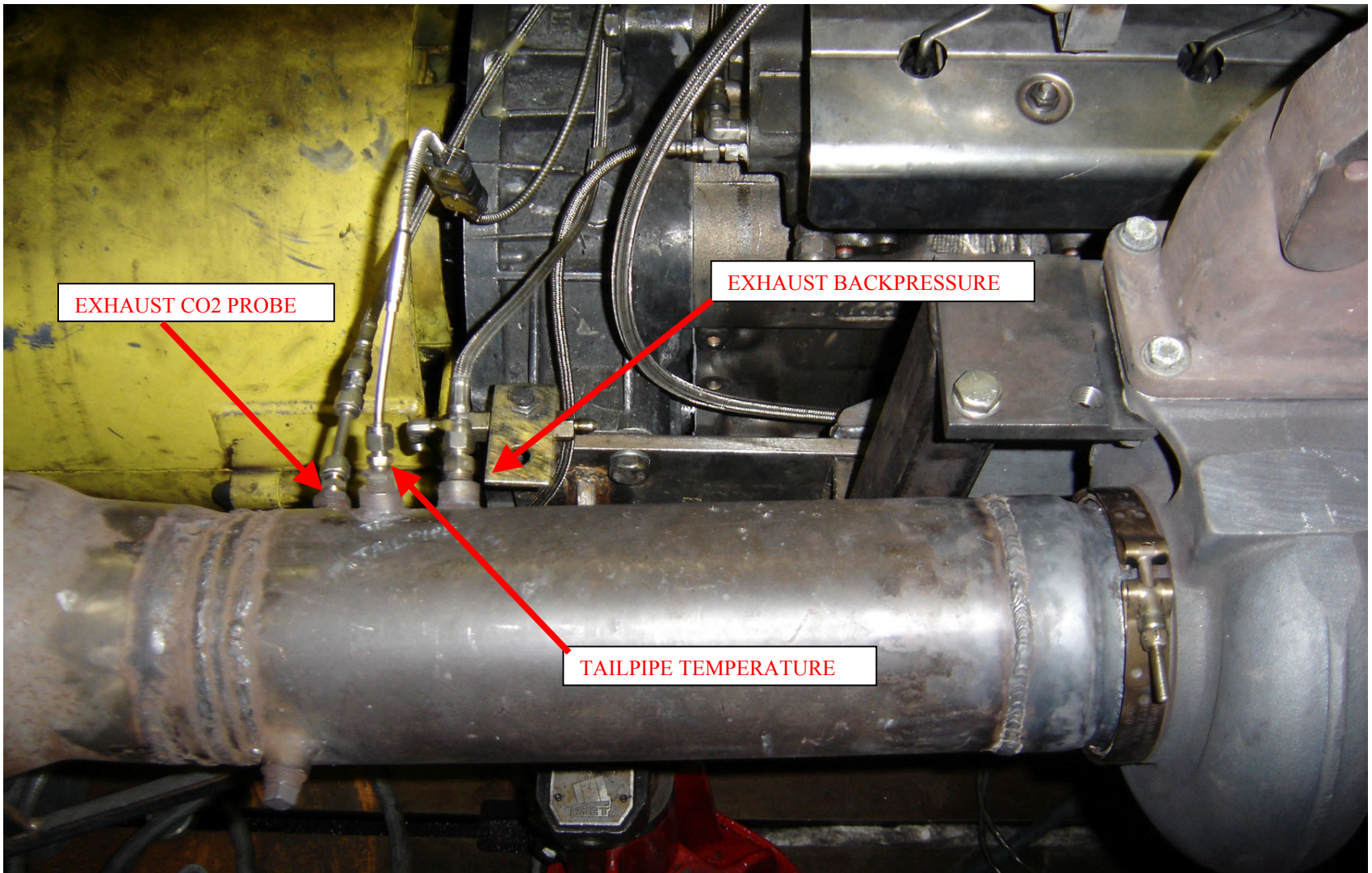
**FIG. A1.9 INTAKE AIR TEMPERATURE AND PRESSURE**



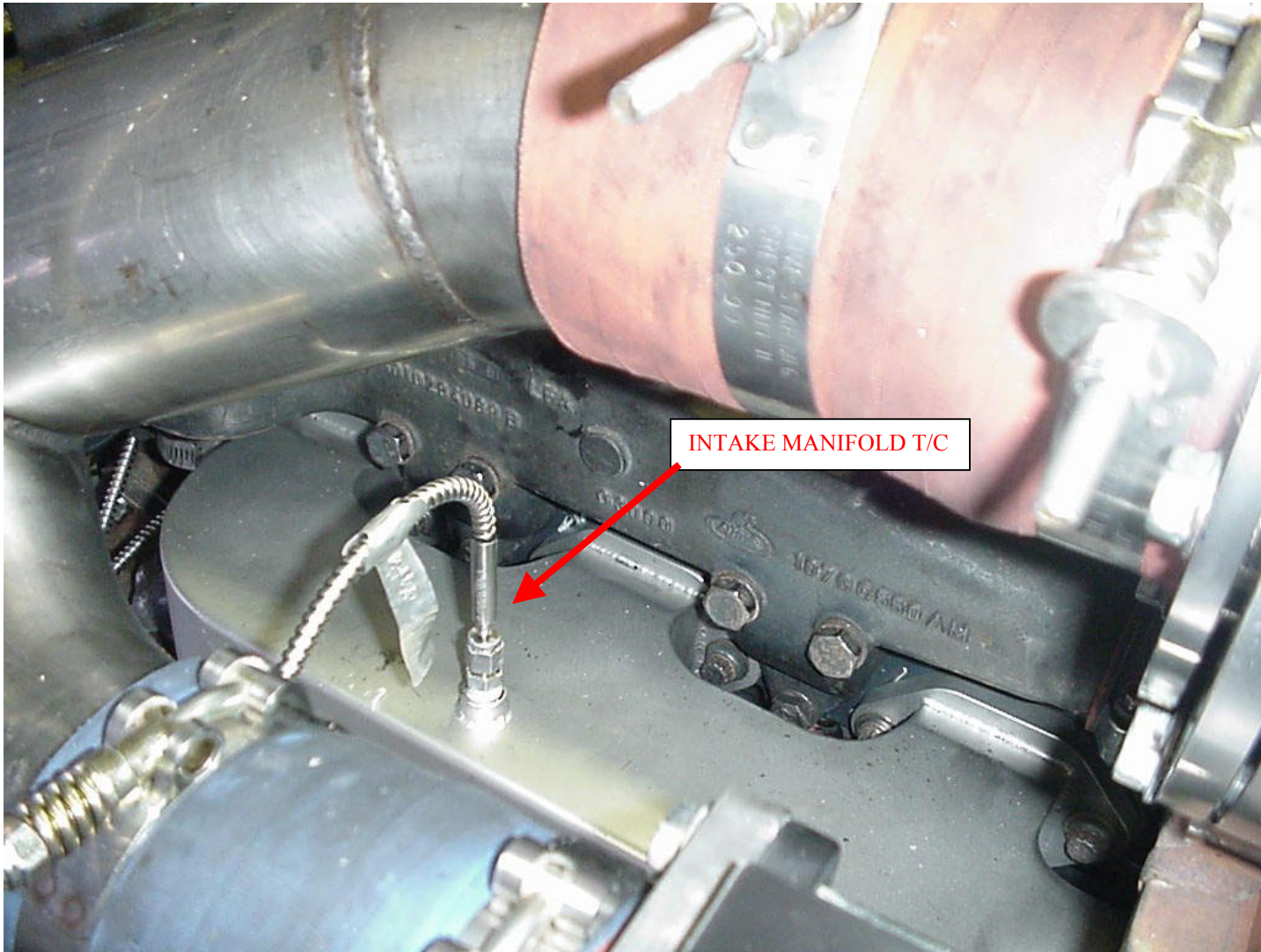
**FIG. A1.10 FUEL IN TEMPERATURE**



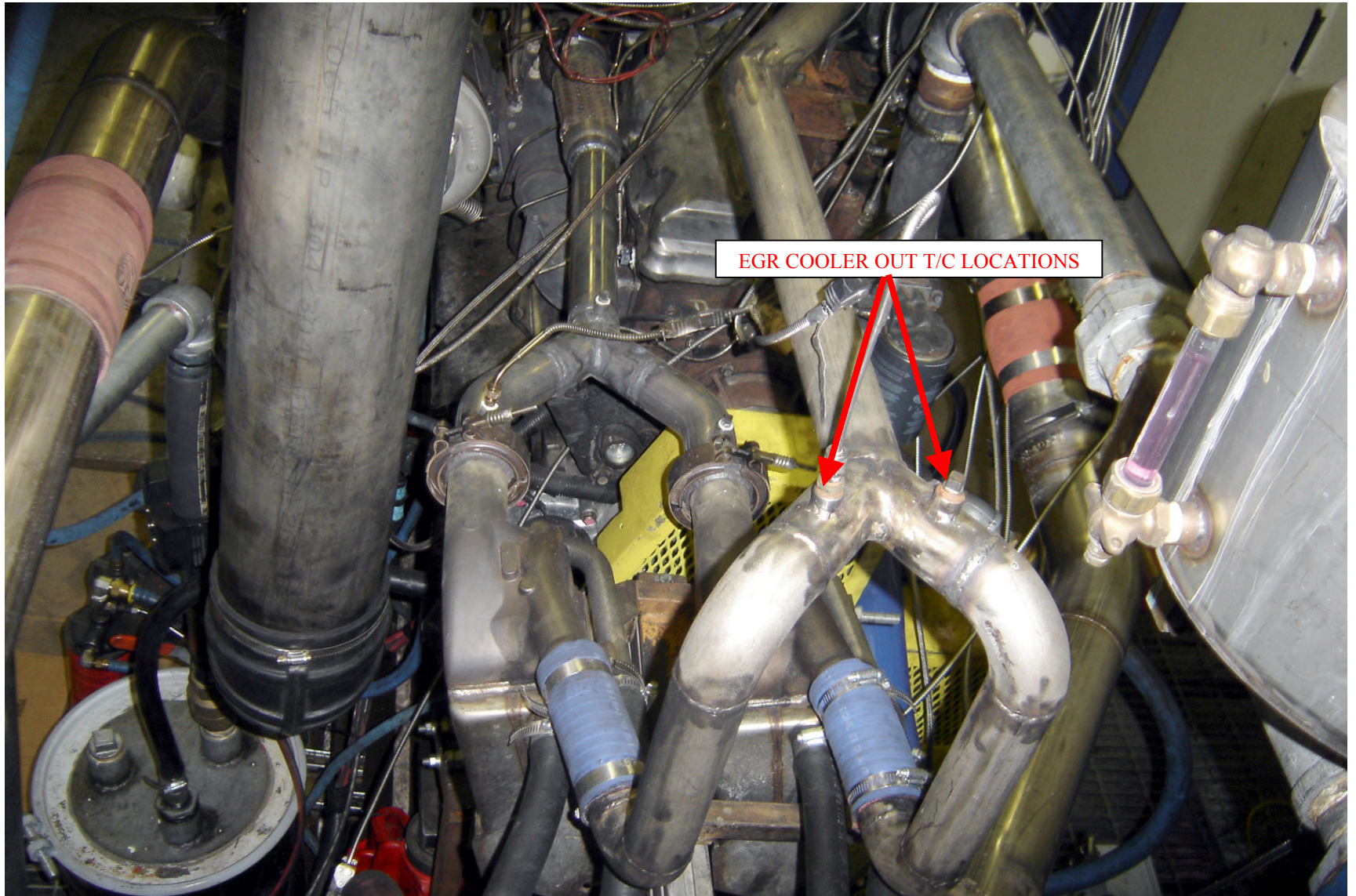
**FIG. A1.11 EXHAUST PRE-TURBINE TEMPERATURE AND PRESSURE, FRONT AND REAR**



**FIG. A1.12**  
**EXHAUST BACKPRESSURE, TAILPIPE TEMPERATURE, AND CO<sub>2</sub> SENSOR**



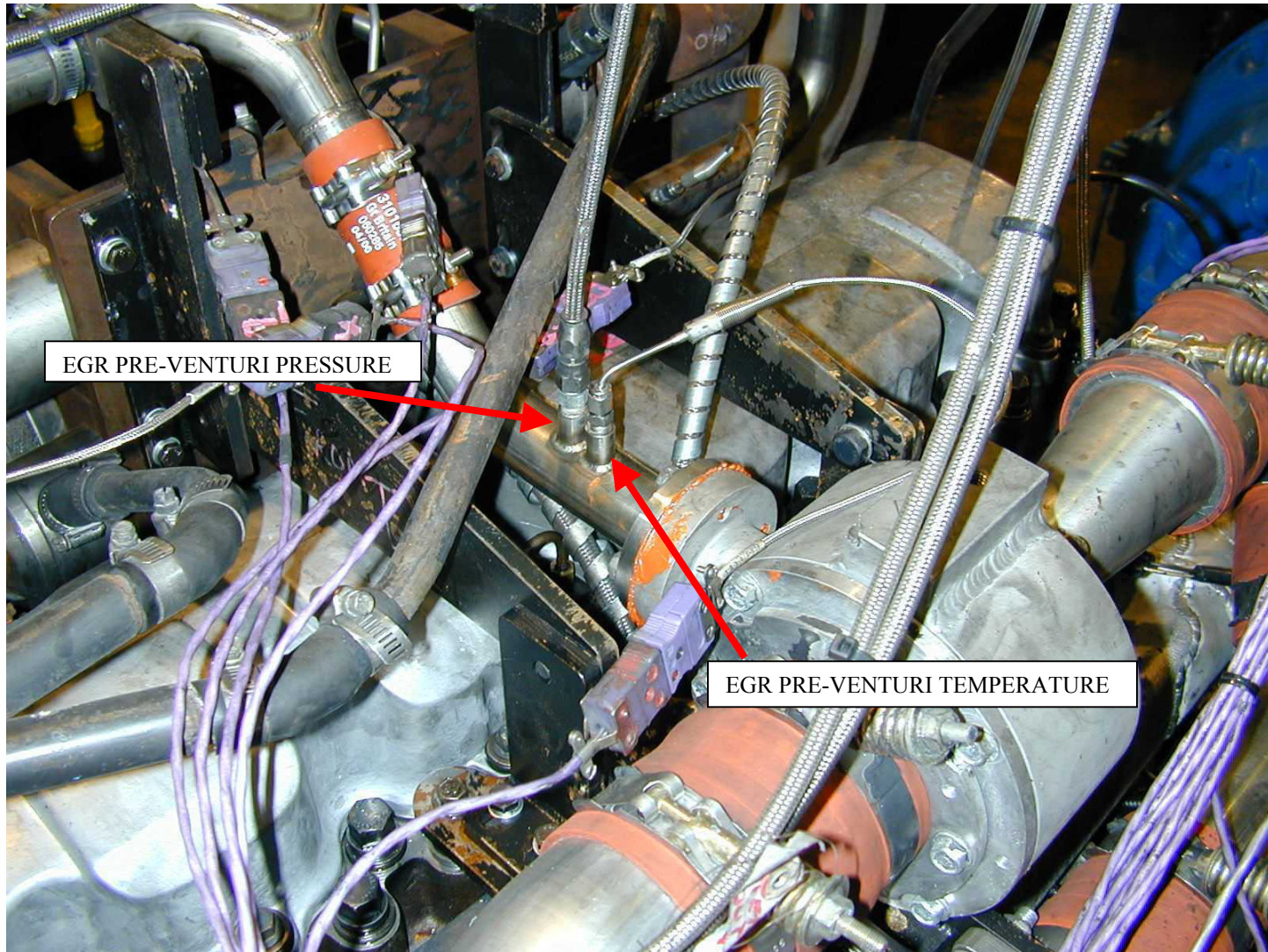
**FIG. A1.13 INTAKE MANIFOLD TEMPERATURE**



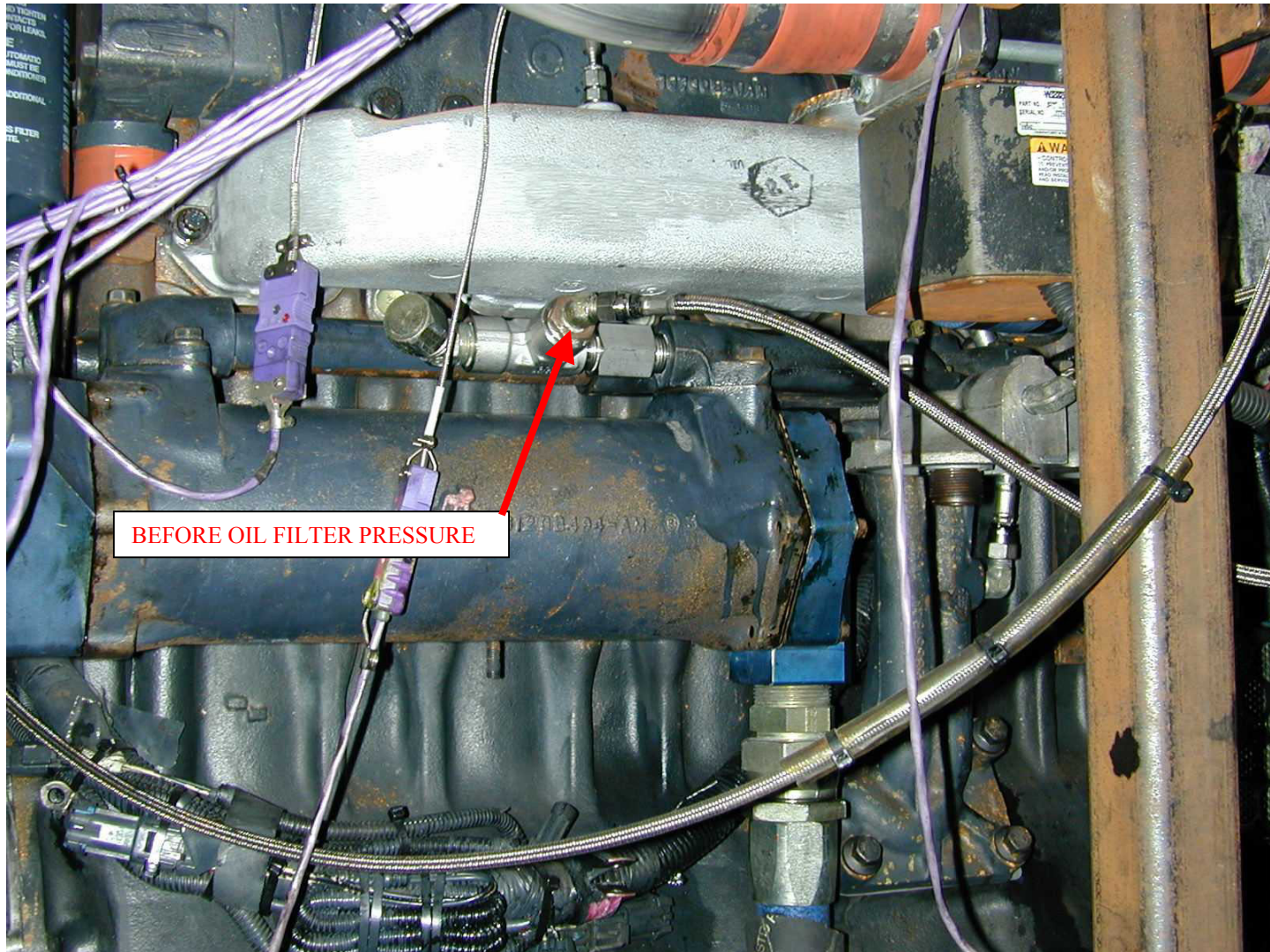
EGR COOLER OUT T/C LOCATIONS

**FIG. A1.14 EGR COOLER OUT TEMPERATURE**

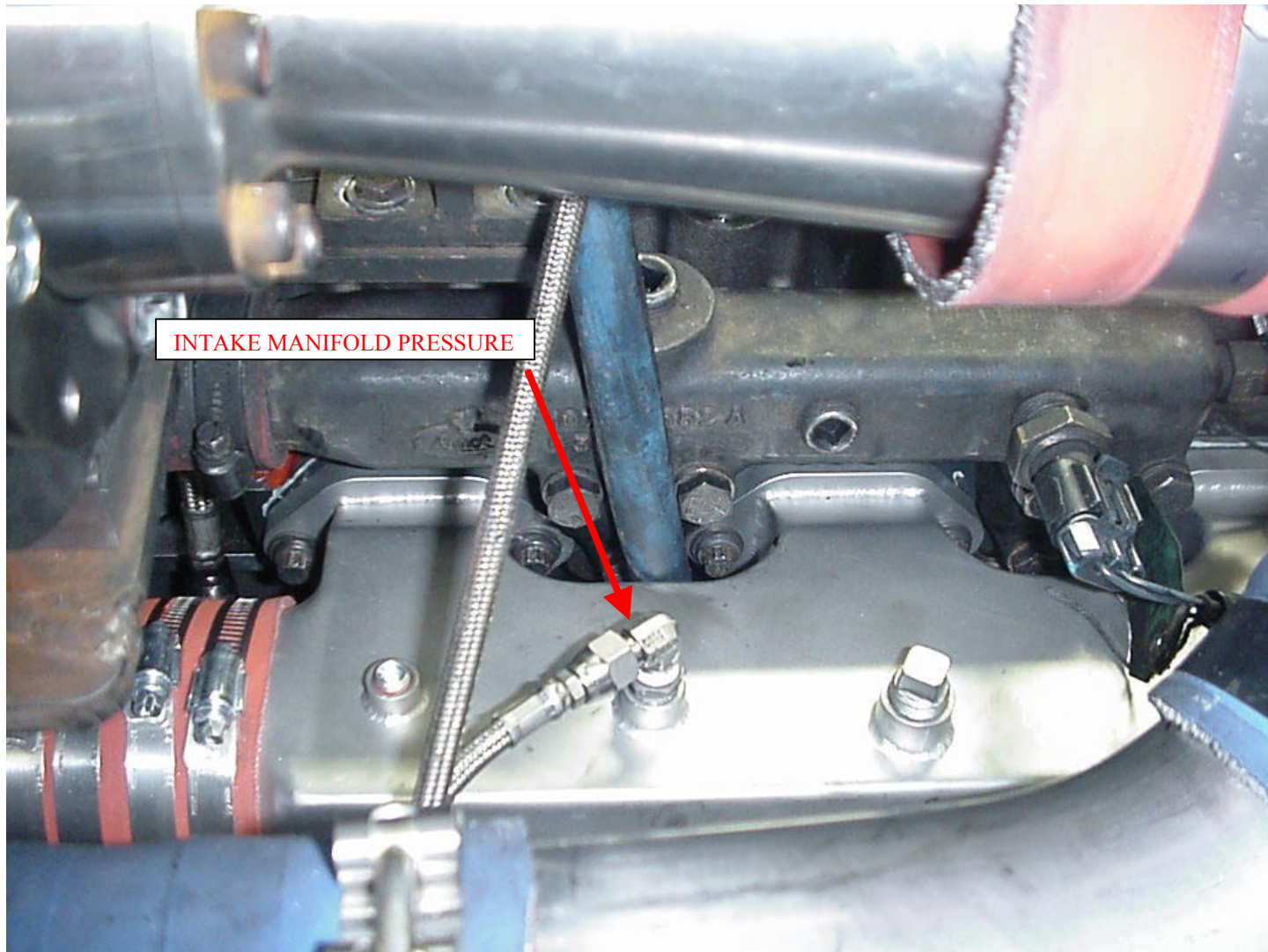




**FIG. A1.15 EGR PRE-VENTURI TEMPERATURE AND PRESSURE**



**FIG. A1.16 BEFORE OIL FILTER PRESSURE**



**FIG. A1.17 INTAKE MANIFOLD PRESSURE**

**A2. PROCUREMENT OF TEST MATERIALS**

A2.1 Throughout the text, references are made to necessary hardware, reagents, materials and apparatus. In many cases, for the sake of uniformity and ease of acquisition, certain suppliers are named. If substitutions are deemed appropriate for the specified suppliers, obtain permission to substitute in writing from the TMC before such substitutions will be considered to be *equivalent*. The following entries of the annex represent a consolidated listing of the ordering information necessary to complete the references found in the text.

A2.2 The test engine (P/N 11GBA81025) and 2002 cylinder heads (P/N 732GB3494M2) are available from:

Mack Trucks, Inc.  
13302 Pennsylvania Avenue  
Hagerstown, MD 21742

The intake manifold, oil pump, EGR venturi unit, and injector nozzles (P/N 736GB419M3) and the parts shown in Tables A2.1 and Table A2.2 are available from:

Test Engineering, Inc.  
12718 Cimarron Path  
San Antonio, TX 78249-3423

A2.3 *Air Filtration*  
Mack air filter element (p/n 57MD33) and Mack air filter housing (p/n 2MD3183) are available from Mack Trucks, Inc.

A2.4 *Intercooler*  
The Modine cooler (Mack P/N 305781B; Waukesha P/N 1A16656D) is available from:

Kraft Power Corporation  
1229 Nissley Road  
Lancaster, PA 17601

A2.5 Cleaning solvent is available from local petroleum product suppliers.

A2.6 Ultra-Low Sulfur Diesel Fuel is available from:

Chevron Phillips  
Phillips 66 Co. Marketing Services Center  
P.O. Box 968  
Borger, TX 79008-0968

A2.7 Oil cooler adapter blocks are available from:  
Southwest Research Institute  
6220 Culebra Road  
P.O. Drawer 28510  
San Antonio, TX 78228-0510

Ph: 210-522-5244  
Fax: 210-523-6919

A2.8            Pencool 3000 is available from The Penray Companies, Inc., 100 Crescent Center Pkwy., Suite 104, Tucker, GA 30084.

**TABLE A2.1  
NEW PARTS FOR EACH REBUILD**

PART NAME	MACK PART NUMBER	QUANTITY
1. Cylinder liners <sup>4</sup>	509GC471	6
2. Piston Assembly <sup>4</sup>		
Piston Crown	240GC5125M	6
Piston Skirt	240GC5119M	6
3. Piston Ring Set <sup>4</sup>		
#1 Compression ring	349GC3113	6
#2 Compression ring	349GC3108	6
Oil ring	350GC343	6
4. Overhaul gasket sets	57GC2176	2
	57GC2178A	1
	57GC2179	1
5. Spin-on filters	485GB3236	2
Centrifugal filter cartridge	239GB244B (57GC2134A Kit)	1
6. Engine coolant conditioner	25MF435B	1
7. Primary fuel filter	483GB470AM	1
8. Secondary fuel filter	483GB471M	1
9. Valve guides	714GB3111	24
10. Valve stem seals	446GC332	24
11. Inlet insert	13GC316	12
12. Exhaust insert	13GC317	12
13. Valve stem key	54GC25	48
14. Inlet Valve	690GC410	12
15. Exhaust Valve	688GC344	12
16. Connecting rod bearings	M1062GBT100	6
17. Main Bearings	M1057GCT100	7
18. Thrust Washers	714GC41	2
	714GC42	2

<sup>4</sup> A P/N 57GC3137 cylinder rebuild kit contains items 1, 2, and 3.

A2.9            Keil Probes are available from United Sensor Corp., 3 Northern Blvd., Amherst, NH 03031.

A2.10          Bulldog Oil is available from local Mack Truck dealers.

**Table A2.2  
ENGINE PARTS LIST<sup>4</sup>**

<b>Part Number</b>	<b>Description</b>	<b>Part Number</b>	<b>Description</b>
239GB5551M	Bare Block	3801647RX	Turbocharger (Large)
456GC5140M	Crankshaft	670GC450	Oil Supply Tube
454GC5236A	Camshaft	681GC538	Turbo Drain Tube
59GB37	Cam Bearing	590GB48	Turbo Gaskets
722GC366F	Lifters	616GC279M	Turbo Mounting Studs
732GB3499M	Cylinder head assy	189AM2	Turbo Mounting Studs Nuts
690GC425	Intake Valve	104GC5194M	Exhaust Manifold, Center
688GC344	Exhaust Valve	104GC6154M	Exhaust Manifold, Ends
575GC36	Valve Springs	573GB260	Exhaust Manifold Gaskets
575GC1115	Valve Springs, Exh inner	28GB519	EGR Cooler
54GC25	Valve Stem Key	691GC514C	EGR Valve
446GC332	Valve Stem Seal	573GB323	EGR Valve Gaskets
722GC313A	Intake (rotocoil) Washer	616GC228M3	EGR Valve Mounting Studs
722GC320	Exhaust (rotocoil) Washer	142GC247M	EGR Valve Mounting Studs Nuts
183GC2257	Yoke Pin	744GB357	EGR Valve Oil Drain Hose Assembly
722GC321	Top Washer	744GB356	EGR Valve Oil Supply Hose
485GB3236	Oil Filter	670GC579	EGR Hot Tube
27GB525M	Oil Filter Housing	260GB215	Clamps
315GC465BM	Oil Pump Assembly	449GC236M	Gaskets
530GB3170M	Flywheel	744GB360	Stepped Hoses
762GBX433SS	Venturi (ss)	180GB330M58	Clamps
M10105GCX4332/52121	Intake Manifold (ss)	180GB330M47	Clamps
5424*1A166566D*	Modine Intercooler	744GB261	Hose
631GC5176M7	Turbocharger	491GC412	Heat Shield
736GB419M3	Injector Nozzles	240GB5240M	Oil Pan
203GC4380AM	Injection Lines		

<sup>4</sup>Table A2.2 contains the list of parts, that when combined with the new parts needed for each rebuild (Table A2.1), make up the complete engine. The parts in Table A2.2 do not need to be replaced at each rebuild and may be reused. The inspection and replacement of these parts is at the discretion of the test laboratory.

### **A3. DETERMINATION OF OPERATIONAL VALIDITY**

#### *A3.1 Quality Index Calculation*

- A3.1.1 Calculate Quality Index (QI) for all control parameters according to the DACA II Report. Be sure to account for missing or bad quality data according to the DACA II Report as well.
- A3.1.2 Use the U, L, Over Range, and Under Range values shown in Table A3.1 for the QI calculations.
- A3.1.3 Do not use the data from the first six min of Phase II. This is considered transition time and the data is not to be used to calculate QI.
- A3.1.4 Round the calculated QI values to the nearest 0.001.
- A3.1.5 Report the QI values on Form5.

#### *A3.2 Averages*

- A3.2.1 Calculate averages for all control, ranged, and non-control parameters and report the values on Form 5.
- A3.2.2 The averages for control and non-control parameters are not directly used to determine operational validity but they may be helpful when an engineering review is required (refer to section A3.4).

#### *A3.3 Determining Operational Validity*

- A3.3.1 QI threshold values for operational validity are shown in Table A3.1. Specifications for all ranged parameters are shown in Table A3.1.
  - A3.3.1.1 A test with EOT QI values for all control parameters equal to or above the threshold values and with averages for all ranged parameters within specifications is operationally valid, provided that no other operational deviations exist that may cause the test to be declared invalid.
  - A3.3.1.2 A test with any control parameter QI value less than the threshold value requires an engineering review to determine operational validity (Section A3.4).
  - A3.3.1.3 With the exception of crankcase pressure, a test with a ranged parameter average value outside the specification is invalid. A test with crankcase pressure outside the specification requires an engineering review to determine operational validity.

#### *A3.4 Engineering Review*

- A3.4.1 Conduct an engineering review when a control parameter QI value is below the threshold value. A typical engineering review involves investigation of the test data to determine the cause of the below threshold QI. Other affected parameters may also be included in the engineering review. This can be helpful in determining if a real control problem existed and the possible extent to which it may have impacted the test. For example, a test runs with a low QI for fuel flow. An examination of the fuel flow data may show that the fuel flow data contains several over range values. At this point, an examination of

exhaust temperatures may help determine whether the instrumentation problem affected real fuel flow versus affecting only the data acquisition.

A3.4.2 For reference oil tests, the engineering review shall be conducted jointly with the TMC. For non-reference oil tests, optional input is available from the TMC for the engineering review.

A3.4.3 Determine operational validity based upon the engineering review and summarize the decision in the comment section on Form 11. It may be helpful to include any supporting documentation at the end of the test report. The final decision regarding operational validity rests with the laboratory.

**TABLE A3.1  
QUALITY INDEX AND AVERAGE CALCULATION VALUES**

Control Parameter	Units	Quality Index Threshold		Quality Index U & L Values				Over & Under Range Values	
				U		L		Low	High
Speed <sup>4</sup>	r/min	0.000		1802.5	1202.5	1797.5	1197.5	1063	1937
Fuel Flow <sup>4</sup>	kg/h	0.000		60.20	64.50	58.20	62.50	4.4	118.3
Inlet Manifold Temp.	°C	0.000		80.8		79.2		33.4	126.5
Coolant Out Temp.	°C	0.000		66.9	108.9	65.1	107.1	16.7	157.3
Fuel In Temp.	°C	0.000		40.5		39.5		12.6	67.4
Oil Gallery Temp.	°C	0.000		88.6	116.6	87.4	115.4	55.1	148.9
Intake Air Temp.	°C	0.000		26.0		24.0		-29.8	79.8
Ranged Parameter	Units	Range						Over & Under Range Values	
Inlet Air Restriction	kPa	3.5 – 4.0						0	14
Inlet Manifold Pressure	kPa	Tbd	Tbd					0	400
Exhaust Back Pressure	kPa	2.7 – 3.5						0	16
Crankcase Pressure	kPa	0.25 – 0.75						0	3
Intake CO <sub>2</sub>	%	3.09±0.05	1.42 ± 0.05					0	5

<sup>4</sup>U and L values for speed, fuel flow, coolant out temperature, and oil gallery temperature are split by test phase.



**A4. TEMPERATURE TO INJECTION TIMING CORRELATION**

<b>Intake Manifold Temperature</b>	<b>Injection Timing (°BTDC)</b>
30	21
40	18
50	15
60	12
70	9
80	6
90	3

## A5. BREAK-IN, START-UP, SHUTDOWN, AND TRANSITION PROCEDURES

- A5.1 The break-in sequence is shown in Table A5.1.
- A5.2 The Phase I start-up sequence is shown in Table A5.2.
- A5.3 The Phase II start-up sequence is shown in Table A5.3.
- A5.4 The shutdown sequence for Phases I and II is shown in Table A5.4.
- A5.5 The transition sequence from Phase I to Phase II is shown in Table A5.5.
- A5.6 Emergency (or hard) shutdowns are considered a laboratory safety procedure and are not specified by this test method.
- A5.7 The torque values in Tables A5.1 through A5.5 are nominal values. Run the appropriate fuel rates to achieve the nominal torque values.

**TABLE A5.1 BREAK-IN SEQUENCE**

Step	Time (h:mm:ss)	Speed (r/min)	Torque (N•m)	Comments
Prior to start				Set injection timing to 21° BTDC and full EGR bypass, EGR valve closed, VGT pressure below 60 psi
1	0:00:00	idle	0	Engine idle, waiting for oil pressure
	0:00:10	idle	0	Proceed if oil pressure > 138 kPa
2	0:00:11	idle	245	Engine idle, set torque to 245, hold conditions for 4 min 50 s
3	0:05:00	1200	245	Set speed to 1200, linearly ramp torque to 815 in 4 min
	0:09:00	1200	815	End of torque ramp, hold conditions for 2 min 30 s
4	0:11:30	1200	815	Linearly ramp torque to 1085 in 2 min
	0:13:30	1200	1085	End of torque ramp, hold conditions for 2 min 30 s
5	0:16:00	1200	1085	Linearly ramp torque to 2440 in 10 min Open EGR valve, Set EGR (tbd)
	0:26:00	1200	2440	End of torque ramp, hold conditions for 2 min 30 s
	0:28:30	1200	2440	Hold conditions for 30 min
6	0:58:30	1200	2440	Linearly ramp torque to 1300 in 2 min
	0:59:00	1200	ramping	Linearly ramp speed to 1800 in 2 min
	1:00:30	ramping	1300	End of torque ramp
	1:01:00	1800	1300	End of speed ramp, hold conditions for 2 min 30 s
	1:03:30	1800	1300	Set injection timing to 6° BTDC and EGR (tbd), hold conditions for 30 min
7	1:33:30	1800	1300	Proceed to shutdown sequence

**TABLE A5.2 PHASE I START-UP SEQUENCE**

Step	Time (h:mm:ss)	Speed (r/min)	Torque (N•m)	Comments
Prior to start				Set injection timing to 21° BTDC and full EGR bypass, EGR valve closed, VGT pressure below 60 psi
1	0:00:00	idle	0	Engine idle, waiting for oil pressure
	0:00:10	idle	0	Proceed if oil pressure > 138 kPa
2	0:00:11	idle	245	Engine idle, set torque to 245, hold conditions for 4 min 50 s
3	0:05:00	1200	245	Set speed to 1200, linearly ramp torque to 815 in 4 min
	0:09:00	1200	815	End of torque ramp, hold conditions for 2 min 30 s; begin opening the venturi and control the VGT as necessary to get to test conditions by the end of the start-up
4	0:11:30	1800	815	Set speed to 1800, linearly ramp torque to 1085 in 2 min
	0:13:30	1800	1085	End of torque ramp, hold conditions for 2 min 30 s
5	0:16:00	1800	1085	Linearly ramp torque to 1300 in 2 min
	0:18:00	1800	1300	End of torque ramp, hold conditions for 2 min 30 s
	0:20:30	1800	1300	Set injection timing, set EGR, proceed to Phase I, set fuel rate

**TABLE A5.3 PHASE II START-UP SEQUENCE**

Step	Time (h:mm:ss)	Speed (r/min)	Torque (N•m)	Comments
Prior to start				Set injection timing to 21° BTDC and full EGR bypass, EGR valve closed, VGT pressure below 60 psi
1	0:00:00	idle	0	Engine idle, waiting for oil pressure
	0:00:10	idle	0	Proceed if oil pressure > 138 kPa
2	0:00:11	idle	245	Engine idle, set torque to 245, hold conditions for 4 min 50 s
3	0:05:00	1200	245	Set speed to 1200, linearly ramp torque to 815 in 4 min
	0:09:00	1200	815	End of torque ramp, hold conditions for 2 min 30 s; begin opening the venturi and control the VGT as necessary to get to test conditions by the end of the start-up
4	0:11:30	1200	815	Linearly ramp torque to 2440 in 10 min
	0:21:30	1200	2440	End of torque ramp, hold conditions for 2 min 30 s
5	0:24:00	1200	2440	Set EGR, proceed to Phase II, set fuel rate

**TABLE A5.4 SHUTDOWN SEQUENCE, PHASES I AND II**

Step	Time (h:mm:ss)	Speed (r/min)	Torque (N•m)	Comments
Prior to start of shutdown sequence				Engine running at test conditions, either Phase I or II
1	0:00:00	1800/1200	1300/2440	Set EGR to full bypass, linearly ramp torque to 815 in 1 min
	0:01:00	1800/1200	815	End of torque ramp, hold conditions for 1 min
2	0:02:00	1800/1200	815	Linearly ramp torque to 270 in 1 min 30 s
	0:03:30	1800/1200	270	End of torque ramp, hold conditions for 3 min 30 s
3	0:07:00	1800/1200	270	Linearly ramp torque to 0 in 1 min, linearly ramp speed to idle in 2 min
	0:08:00	Ramping	0	End of torque ramp
	0:09:00	Idle	0	End of speed ramp, hold conditions for 1 min
4	0:10:00	Idle	0	Stop engine in 1 s
	0:10:01	0	0	End of shutdown

**TABLE A5.5 TRANSITION SEQUENCE FROM PHASE I TO PHASE II**

<b>Step</b>	<b>Time (h:mm:ss)</b>	<b>Speed (r/min)</b>	<b>Torque (N•m)</b>	<b>Comments</b>
Prior to start of sequence				Phase I has completed, set injection timing to 21° BTDC
1	0:00:00	1800	1300	Linearly ramp speed to 1200 in 2 min 30 s
	0:02:00	ramping	1300	Linearly ramp torque to 2440 in 2 min 30 s
	0:02:30	1200	ramping	End of speed ramp
	0:04:30	1200	2440	End of torque ramp, hold conditions for 2 min 30 s
2	0:07:00	1200	2440	Set EGR and fuel rate, proceed to Phase II

## A6. SAFETY PRECAUTIONS

### A6.1 *General*

- A6.1.1 The operating of engine tests can expose personnel and facilities to a number of safety hazards. It is recommended that only personnel who are thoroughly trained and experienced in engine testing should undertake the design, installation and operation of engine test stands.
- A6.1.2 Each laboratory conducting engine tests should have their test installation inspected and approved by their Safety Department. Personnel working on the engines should be provided with proper tools, be alert to common sense safety practices, and avoid contact with moving, and hot engine parts, or both. Guards should be installed around all external moving or hot parts. When engines are operating at high speeds, heavy duty guards are required and personnel should be cautioned against working alongside the engine and coupling shaft. Barrier protection should be provided for personnel. All fuel lines, oil lines, and electrical wiring should be properly routed, guarded, and kept in good order. Scraped knuckles, minor burns, and cuts are common if proper safety precautions are not taken. Safety masks or glasses should always be worn by personnel working on the engines and no loose or flowing clothing, including long hair or other accessory to dress which could become entangled, should be worn near running engines.
- A6.1.3 The external parts of the engines and the floor area around the engines should be kept clean and free of oil and fuel spills. In addition, all working areas should be free of tripping hazards. Personnel should be alert for leaking fuel or exhaust gas. Leaking fuel represents a fire hazard and exhaust gas fumes are noxious. Containers of oil or fuel cannot be permitted to accumulate in the testing area.
- A6.1.4 The test installation should be equipped with a fuel shut-off valve which is designed to automatically cutoff the fuel supply to engine when the engine is not running. A remote station for cutting off fuel from the test stand is recommended. Suitable interlocks should be provided so that the engine is automatically shutdown when any of the following events occur: engine or dynamometer water temperature becomes excessive; engine loses oil pressure; dynamometer loses field current; engine overspeeds; exhaust system fails; room ventilation fails; or the fire protection system is activated.
- A6.1.5 Consider an excessive vibration pickup interlock if equipment operates unattended. Fixed fire protection equipment should be provided.
- A6.1.6 Normal precautions should be observed whenever using flammable solvents for cleaning purposes. Make sure adequate fire fighting equipment is immediately accessible.

This standard is subject to revision at any time by the responsible technical committee and shall be reviewed every five years and if not revised, either reapproved or withdrawn. Your comments are invited either for revision of this standard or for additional standards and should be addressed to ASTM Headquarters. Your comments will receive careful consideration at a meeting of the responsible technical committee, which you may attend. If you feel that your comments have not received a fair hearing, you should make your views known to the ASTM Committee on Standards, 100 Barr Harbor Drive, West Conshohocken, PA 19428-2959.

---

<sup>1</sup>This test method is under the jurisdiction of ASTM Committee D02 on Petroleum Products and Lubricants and is the direct responsibility of Subcommittee D02.0B on Automotive Lubricants. Current edition approved MMMM DD, YYYY. Published MMM YYYY

<sup>2</sup>The American Society for Testing and Materials takes no position respecting the validity of any patent rights asserted in connection with any item mentioned in this standard. Users of this standard are expressly advised that determination of the validity of any such patent rights, and the risk of infringement of such rights, are entirely their own responsibility.

<sup>3</sup>The ASTM Test Monitoring Center will update changes in this test method by means of Information Letters. This edition includes all information letters through xx-xx. Information letters may be obtained from the ASTM Test Monitoring Center, 6555 Penn Avenue, Pittsburgh, PA 15206-4489, Attention: Administrator.

<sup>4</sup>Annual Book of ASTM Standards, VOL 05.01

<sup>5</sup>Annual Book of ASTM Standards, VOL 05.02

<sup>6</sup>Annual Book of ASTM Standards, VOL 05.03

<sup>7</sup>Annual Book of ASTM Standards, VOL 05.04

<sup>8</sup>Annual Book of ASTM Standards, VOL 14.02

<sup>9</sup>Annual Book of ASTM Standards, VOL 14.03

<sup>10</sup> Available from Robert Bosch GmbH, Postfach 50, D-7000 Stuttgart 1., Germany.

<sup>11</sup> Subcommittee B Glossary may be obtained from the ASTM Test Monitoring Center, 6555 Penn Avenue, Pittsburgh, PA 15206-4489, Attention: Administrator.

<sup>12</sup> Aeroquip lines are available at local industrial hose suppliers.

<sup>13</sup> Available from Viking Pump, Inc., A Unit of IDEX Corporation, 406 State Street, P.O. Box 8, Cedar Falls, Iowa 50613-0008

<sup>14</sup> Mack Service Manuals are available from local Mack Trucks, Inc. distributors.

<sup>15</sup> The Data Acquisition and Control Automation II Task Force Report may be obtained from the ASTM Test Monitoring Center, 6555 Penn Avenue, Pittsburgh, PA 15206-4489, Attention: Administrator.

<sup>16</sup> The Lubricant Test Monitoring System may be obtained from the ASTM Test Monitoring Center, 6555 Penn Avenue, Pittsburgh, PA 15206-4489, Attention: Administrator.

<sup>17</sup> Available from ASTM, 100 Barr Harbor Drive, West Conshocken, PA 19428-2959