

DRAFT NO. 5 – September 18, 2003

ASTM Designation: DXXXX - XX

## STANDARD TEST METHOD FOR EVALUATION OF DIESEL ENGINE OILS IN THE T-11 EXHAUST GAS RECIRCULATION DIESEL ENGINE<sup>1</sup>

This standard is issued under the fixed designation D XXXX; the number immediately following the designation indicates the year of original adoption or, in the case of revision, the year of last revision. A number in parentheses indicates the year of last reapproval.

### 1. Scope

- 1.1 This test method is commonly referred to as the Mack T-11.<sup>2</sup> This test method covers an engine test procedure for evaluating diesel engine oils for performance characteristics in a diesel engine equipped with exhaust gas recirculation, including viscosity increase and soot concentrations (loading).<sup>3</sup>
- 1.2 The values stated in either SI or inch-pound units are to be regarded separately as the standard. Within the test method, the inch-pound units are shown in parentheses when combined with SI units.
- 1.3 *This standard does not purport to address all of the safety concerns, if any, associated with its use. It is the responsibility of the user of this standard to establish appropriate safety and health practices and determine the applicability of regulatory limitations prior to use. See Annex A6 for specific Safety Precautions.*

### 2. Referenced Documents

- 2.1 *ASTM Standards*
  - D 86 Test Method for Distillation of Petroleum Products<sup>4</sup>
  - D 93 Test Methods for Flash Point by Pensky-Martens Closed Tester<sup>4</sup>
  - D 97 Test Method for Pour Point of Petroleum Products<sup>4</sup>
  - D 129 Test Method for Sulfur in Petroleum Products (General Bomb Method)<sup>4</sup>
  - D 130 Test Method for Detection of Copper Corrosion from Petroleum Products by the Copper Strip Tarnish Test<sup>4</sup>
  - D 235 Standard Specification for Mineral Spirits (Petroleum Spirits) (Hydrocarbon Dry Cleaning Solvent)<sup>5</sup>
  - D 287 Test Method for API Gravity of Crude Petroleum and Petroleum Products (Hydrometer Method)<sup>4</sup>
  - D 445 Test Method for Kinematic Viscosity of Transparent and Opaque Liquids (and the Calculation of Dynamic Viscosity)<sup>4</sup>
  - D 482 Test Method for Ash from Petroleum Products<sup>4</sup>
  - D 524 Test Method for Ramsbottom Carbon Residue of Petroleum Products<sup>4</sup>
  - D 613 Test Method for Ignition Quality of Diesel Fuels by the Cetane Method<sup>4</sup>
  - D 664 Test Method for Acid Number of Petroleum Products by Potentiometric Titration<sup>4</sup>
  - D 976 Test Methods for Calculated Cetane Index of Distillate Fuels<sup>4</sup>

D 1319 Test Method for Hydrocarbon Types in Liquid Petroleum Products by Fluorescent Indicator Absorbance<sup>4</sup>  
D 2274 Test Method for Oxidation Stability of Distillate Fuel Oil (Accelerated Method)<sup>4</sup>  
D 2500 Test Method for Cloud Point of Petroleum Products<sup>4</sup>  
D 2622 Test Method for Sulfur in Petroleum Products by X-Ray Spectrometry<sup>6</sup>  
D 2709 Test Method for Water and Sediment in Distillate Fuels by Centrifuge<sup>6</sup>  
D 3524 Test Method for Diesel Fuel Diluent in Used Diesel Engine Oils by Gas Chromatography<sup>6</sup>  
D 4052 Test Method for Density and Relative Density of Liquids by Digital Density Meter<sup>6</sup>  
D 4485 Specification for Performance of Engine Oils<sup>6</sup>  
D 4737 Test Method for Calculated Cetane Index by Four Variable Equation<sup>7</sup>  
D 4739 Test Method for Base Number Determination by Potentiometric Titration<sup>7</sup>  
D 5185 Test Method for Determination of Additive Elements, Wear Metals, and Contaminants in Used Lubricating Oils by Inductively Coupled Plasma Atomic Emission Spectrometry<sup>7</sup>  
D 5302 Test Method for Evaluation of Automotive Engine Oils for Inhibition of Deposit Formation and Wear in a Spark-Ignition Internal Combustion Engine Fueled with Gasoline and Operated Under Low-Temperature, Light Duty Conditions<sup>7</sup>  
D 5844 Test Method for Evaluation of Automotive Engine Oils for Inhibition of Rusting<sup>7</sup>  
D 5967 Test Method for Evaluation of Diesel Engine Oils in T-8 Diesel Engine<sup>8</sup>  
D 6278 Test Method for Shear Stability of Polymer-Containing Fluids Using European Diesel Injector Apparatus<sup>8</sup>  
D 6483 Test Method for Evaluation of Diesel Engine Oils in T-9 Diesel Engine<sup>8</sup>  
D 6681 Test Method for Evaluation of Engine Oils in a High Speed, Single-Cylinder Diesel Engine – Caterpillar 1P Test Procedure<sup>8</sup>  
D 6896 Test Method for Determination of Yield Stress and Apparent Viscosity of Used Engine Oils at Low Temperature<sup>8</sup>  
E 29 Practice for Using Significant Digits in Test Data to Determine Conformance With Specifications<sup>9</sup>  
E 178 Standard Practice for Dealing With Outlying Observations<sup>9</sup>  
E 344 Terminology Relating to Thermometry in Hydrometry<sup>10</sup>

### 3. Terminology

#### 3.1 Definitions

- 3.1.1 *blind reference oil, n* – a reference oil, the identity of which is unknown by the test facility.
- 3.1.1.1 *Discussion* – This is a coded reference oil that is submitted by a source independent from the test facility. **(D 5844)**
- 3.1.2 *blowby, n* – in internal combustion engines, the combustion products and unburned air-and-fuel mixture that enter the crankcase. **(D 5302)**
- 3.1.3 *calibrate, v* – to determine the indication or output of a measuring device with respect to that of a standard. **(E 344)**
- 3.1.4 *candidate oil, n* – an oil that is intended to have the performance characteristics necessary to satisfy a specification and is intended to be tested against that specification. **(D 5844)**
- 3.1.5 *exhaust gas recirculation (EGR), n* – the mixing of exhaust gas with intake air to reduce the formation of nitrogen oxides (NO<sub>x</sub>). **(Automotive Handbook<sup>11</sup>)**

- 3.1.6 *heavy-duty, adj.* – in internal combustion engine operation, characterized by average speeds, power output and internal temperatures that are close to the potential maximums. **(D 4485)**
- 3.1.7 *heavy-duty engine, n* – in internal combustion engines, one that is designed to allow operation continuously at or close to its peak output. **(D 4485)**
- 3.1.8 *non-reference oil, n* – any oil other than a reference oil; such as a research formulation, commercial oil or candidate oil. **(D 5844)**
- 3.1.9 *non-standard test, n* – a test that is not conducted in conformance with the requirements in the standard test method; such as running on an uncalibrated test stand, using different test equipment, applying different equipment assembly procedures, or using modified operating conditions. **(D 5844)**
- 3.1.10 *oxidation, n* – of engine oil, the reaction of the oil with an electron acceptor, generally oxygen, which can produce deleterious acidic or resinous materials often manifested as sludge formation, varnish formation, viscosity increase, or corrosion, or combination thereof. **(Sub. B Glossary)<sup>12</sup>**
- 3.1.11 *reference oil, n* – an oil of known performance characteristics, used as a basis for comparison.
- 3.1.11.1 *Discussion* – Reference oils are used to calibrate testing facilities, to compare the performance of other oils, or to evaluate other materials (such as seals) that interact with oils. **(D 5844)**
- 3.1.12 *sludge, n* – in internal combustion engines, a deposit, principally composed of insoluble resins and oxidation products from fuel combustion and the lubricant, that does not drain from engine parts but can be removed by wiping with a cloth. **(D 5302)**
- 3.1.13 *standard test, n* – a test on a calibrated test stand, using the prescribed equipment according to the requirements in the test method, and conducted according to the specified operating conditions.
- 3.1.13.1 *Discussion* – The specified operating conditions in some test methods include requirements for determining a test's operational validity. These requirements are applied after a test is completed and can include (1) mid-limit ranges for the *average values* of primary and secondary parameters that are narrower than the specified control ranges for the *individual values*, (2) allowable *deviations* for *individual* primary and secondary parameters for the specified control ranges, (3) downtime limitations, and (4) *special* parameter limitations. **(D 5844)**
- 3.1.14 *varnish, n* – in internal combustion engines, a hard, dry, generally lustrous deposit that can be removed by solvents but not by wiping with a cloth. **(D 5302)**
- 3.1.15 *wear, n* – the loss of material from, or relocation of material on, a surface.
- 3.1.15.1 *Discussion* – Wear generally occurs between two surfaces moving relative to each other, and is the result of mechanical or chemical action or by a combination of mechanical and chemical action. **(D 5302)**

#### **4. Summary of Test Method**

- 4.1 The test operation involves use of a Mack E-TECH V-MAC III diesel engine with Exhaust Gas Recirculation (EGR). Two 30-min oil flushes are followed by a 252-h test at constant speed and load conditions.
- 4.2 Take oil samples periodically and analyze for viscosity increase and soot content.
- 4.3 Rebuild the test engine every ten tests. More frequent engine rebuilds may be necessary as indicated by degradation of test parameters and are left to the discretion of the test laboratory. At rebuild, the power section of the engine is disassembled, solvent-cleaned, and rebuilt, using all new pistons, rings, cylinder liners, valves, and valve guides, in strict accordance with furnished specification.
- 4.4 Solvent-clean the engine crankcase and replace worn or defective parts.
- 4.5 Equip the test stand with appropriate accessories for controlling speed, load, and various engine operating conditions.

#### **5. Significance and Use**

- 5.1 This test method was developed to evaluate the viscosity increase and soot concentration (loading) performance of engine oils in turbocharged and intercooled four-cycle diesel engines equipped with EGR. Obtain results from used oil analysis.
- 5.2 The test method may be used for engine oil specification acceptance when all details of the procedure are followed.

#### **6. Apparatus**

##### *6.1 General Description*

- 6.1.1 The test engine is a Mack E-TECH V-MAC III, electronically controlled fuel injection with six electronic unit pumps, using 2002 cylinder heads (Annex A2). It is an open-chamber, in-line, six-cylinder, four-stroke, turbocharged, charge air-cooled, and compression ignition engine. The bore and stroke are 124 by 165 mm (4 7/8 X 6 1/2 in.), and the displacement is 12 L (728 in<sup>3</sup>).
- 6.1.2 The ambient laboratory atmosphere shall be relatively free of dirt and other contaminants as required by good laboratory standards. Filtering air, controlling temperature, and controlling humidity in the engine buildup area helps prevent accumulation of dirt and other contaminants on engine parts and aids in measuring and selecting parts for assembly.

##### *6.2 The Test Engine*

###### *6.2.1 Mack T-11 Test Engine*

The engine and cylinder heads are available from Mack Trucks, Inc. A complete parts list is shown in Table A2.1, Annex A2. Use test parts on a first-in/first-out basis.

###### *6.2.2 Engine Cooling System*

- 6.2.2.1 Use a new Mack coolant conditioner shown in Table A2.1, Annex A2, every test, to limit scaling in the cooling system. Pressurize the system to 103 kPa (15 psi) at the expansion tank. Use the coolant shown in Section 7.3.1.
- 6.2.2.2 Use a closed-loop, pressurized external engine cooling system composed of a nonferrous core heat exchanger, reservoir, and water-out temperature control valve. The system shall prevent air entrainment and control jacket temperatures within the specified limit. Install a sight glass between the engine and the cooling tower to check for air entrainment and uniform flow in an effort to prevent localized boiling. Block the thermostat wide open.
- 6.2.2.3 Flow the coolant from the engine block fitting to the EGR coolers, see Figure A1.3, Annex A1. Return the EGR coolant flow to the engine coolant-in line, near the coolant pump inlet, see Figure A1.7, Annex A1.
- 6.2.3 *Auxiliary Oil System*  
To maintain a constant oil level in the pan, provide an additional 11.4 L (12 qt) minimum volume sump by using a separate closed tank connected to the engine sump. Circulate oil through the system with an auxiliary pump. The system schematic is shown in Fig. A1.1, Annex A1. The No. 6 and No. 8 lines are to have inside diameters of 10 mm (3/8 in.) and 13 mm (1/2 in.), respectively. Use a minimum No. 8 size vent line. Equivalent lines may be substituted for Aeroquip<sup>13</sup> lines provided they have the proper inside diameters.
- 6.2.3.1 Locate the auxiliary oil system suction line on the exhaust side of the oil pan, so that the inside bottom of the auxiliary oil system suction fitting is 152 mm (6.00 in.) down from the oil pan rail and 178 mm (7.00 in.) back from the front of the pan. Refer to Fig. A1.4, Annex A1. Connect the auxiliary oil system return line to the power steering pump cover on the front timing gear cover. Refer to Fig. A1.5, Annex A1. Connect the auxiliary oil scale vent line to the top of the auxiliary oil sump bucket and the dipstick tube opening.
- 6.2.3.2 Viking Pump Model SG053514 shall be used as the auxiliary oil pumps. Nominal pump speed is 1725 r/min.<sup>14</sup> Shut off the auxiliary oil pumps if the auxiliary oil system goes dry.
- 6.2.3.3 A sight glass may be used to aid in determining the oil level should the auxiliary oil system run dry. An example of a sight glass setup is shown in Fig. A1.18, Annex A1.
- 6.2.4 *Oil Cooling System*
- 6.2.4.1 Use the oil cooler adapter blocks to mount the oil cooler to the engine. The adapter blocks are available from the supplier list in Annex A2.7, Annex A2.
- 6.2.4.2 Use the oil filter housing (part number 27GB525M) shown in Figure A1.8.
- 6.2.5 *Blowby Meter*  
Use a meter capable of providing data at a minimum frequency of 6 min. To prevent blowby condensate from draining back into the engine, the blowby line shall have a downward slope to a collection bucket. The collection bucket shall have a minimum volume of 18.9 L (5 gal). Locate the blowby meter downstream of the collection bucket. The slope of the blowby line downstream of the collection bucket is unspecified.
- 6.2.6 *Air Supply and Filtration*

Use the Mack air filter element and the Mack filter housing shown in A2.3, Annex A2. Replace filter cartridge when 2.5 kPa (10 in. H<sub>2</sub>O) ΔP is reached. Install an adjustable valve (flapper) in the inlet air system at least 2 pipe diameters before any temperature, pressure and humidity measurement devices. Use the valve to maintain inlet air restriction within required specifications.

#### 6.2.7 *Fuel Supply*

Heating, cooling, or both of the fuel supply may be required, and a recommended system is shown in Fig. A1.2, Annex A1.

#### 6.2.8 *Intake Manifold and Temperature Control*

Use stainless steel intake manifolds (P/N M10105GCX4332RSS for front manifold, M10105GCX5212RSS for rear manifold) available from the supplier listed in A2.2, Annex A2. Use a Modine intercooler to control intake manifold temperature (refer to A2.4).

#### 6.2.9 *Injection Timing Control*

Remove the engine intake manifold temperature sensor. Use the intake manifold temperature to control injection timing according to the Temperature to Injection Timing Correlation shown in Annex A4.

#### 6.2.10 *Oil Pump*

Use a Mack P/B 315GC465BM oil pump. The oil pump is available from the supplier listed in A2.2, Annex A2.

#### 6.2.11 *EGR Venturi Unit*

Use a stainless steel EGR venturi unit, P/N 762GBX433SS, available from the supplier listed in A2.2, Annex A2.

#### 6.2.12 *Fuel Pressure Regulator*

Use a P/N 691GC227M2 fuel pressure regulator.

### 7. **Engine Fluids**

#### 7.1 *Test Oil*

7.1.1 Approximately 98 L (26 gal) of test oil are required for the test.

#### 7.2 *Test Fuel*

Obtain test fuel from the supplier shown in A2.6, Annex A2. The required fuel properties and tolerances are shown in Annex A7.<sup>15</sup>

#### 7.3 *Engine Coolant*

7.3.1 Use demineralized water with less than 0.03 g/L (2 grains/gal) of salts or distilled water (do not use antifreeze solutions). Use Pencool 3000 coolant additive at the manufacturer's recommended rate. Pencool 3000 may be obtained from the supplier shown in A2.8, Annex A2.

#### 7.4 *Cleaning Materials*

7.4.1 Use a solvent meeting ASTM D 235, Type II, Class C for cleaning parts. (**Warning** - Use adequate safety precautions with all solvents and cleaners.) Other materials such as diesel fuel may be required by some labs in order to assure parts cleanliness.

## **8. Preparation of Apparatus at Rebuild**

### 8.1 *Cleaning of Parts*

#### 8.1.1 *Engine Block*

Thoroughly spray the engine with solvent to remove any oil remaining from the previous test and air-dry. Additionally, use of an engine parts washer shall be followed by a solvent wash.

#### 8.1.2 *Rocker Covers and Oil Pan*

Remove all sludge, varnish and oil deposits. Rinse with solvent and air-dry. Additionally, use of an engine parts washer shall be followed by a solvent wash.

#### 8.1.3 *Auxiliary Oil System*

Flush all oil lines, galleries and external oil reservoirs first with solvent to remove any previous test oil and then air-dry.

#### 8.1.4 *Oil Cooler and Oil Filter*

Flush the oil cooler and filter lines first with solvent to remove any previous test oil and then air-dry. Additionally, use of an engine parts washer shall be followed by a solvent wash.

#### 8.1.5 *Cylinder Head*

Clean the cylinder heads using a wire brush to remove deposits and rinse with solvent to remove any sludge and oil and then air-dry. Additionally, use of an engine parts washer shall be followed by a solvent wash.

#### 8.1.6 *Intake Manifold*

At a minimum, clean the intake manifold at rebuild. Frequency of cleaning between rebuilds is at the laboratory's discretion. Scrub the manifold using a nylon brush and solvent, and then wash the manifold using an engine parts cleaner.

#### 8.1.7 *EGR Coolers*

Clean by flushing with solvent and then air-drying - see 7.41. At a minimum, clean at rebuild. Frequency of cleaning between rebuilds is at the laboratory's discretion.

#### 8.1.8 *EGR Venturi Unit*

Spray with solvent and scrub with a nylon brush. At a minimum, clean at rebuild. Frequency of cleaning between rebuilds is at the laboratory's discretion.

### 8.2 *Valves, Seats, Guides, and Springs*

Replace valves, valve guides, seat inserts, valve stem keys and valve stem seals at rebuild.

8.2.1 Ream guides to  $0.9525 \pm 0.0013$  cm ( $0.3750 \pm 0.0005$  in.).

### 8.3 *Cylinder Liner, Piston, and Piston Ring Assembly*

#### 8.3.1 *Cylinder Liner Fitting*

For proper heat transfer, fit cylinder liners to the block according to the procedure outlined in the Mack Service Manual<sup>16</sup>.

### 8.3.2 *Piston and Rings*

Cylinder liners, pistons, and rings are provided as a set and should be used as a set. Examine piston rings for any handling damage.

## 8.4 *Injectors and Injection Pumps*

### 8.4.1 *Injectors*

Injector nozzles are available from the supplier shown in A2.2, Annex A2. Check the injector opening pressure at rebuild. Reset the injector opening pressure if it is outside the specification of 24,000 + 2000 kPa (3480 + 290 psi). If operating parameters indicate deterioration of injectors, they may be checked and reset, if necessary.

### 8.4.2 *Injection Pumps*

The electronic unit pumps (EUP) may be changed at any time using the procedure specified in the Mack Service Manual. Be sure to enter the EUP's four digit calibration code into the Engine Control Unit (ECU). The calibration code can be found on the EUP label.

## 8.5 *Assembly Instructions*

### 8.5.1 *General*

The test parts specified for this test are intended to be used without material or dimensional modification. Exceptions, for example, a temporary parts supply problem, shall be approved by the Test Monitoring Center (TMC), and noted in the test report. All replacement test engine parts shall be genuine Mack Truck Inc. parts. Assemble all parts as illustrated in the Mack Service Manual except where otherwise noted. Target all dimensions for the means of the specifications. Use Bulldog Premium EO-N Premium Plus Oil (or later) for lubricating parts during assembly; see A2.10, Annex A2.

#### 8.5.1.1 *Thermostat*

Block the thermostat wide open.

#### 8.5.1.2 *Rod Bearings*

Install new rod bearings at rebuild.

#### 8.5.1.3 *Main Bearings*

Install new main bearings at rebuild.

#### 8.5.1.4 *Piston Undercrown Cooling Nozzles*

Particular care shall be taken in assembling the piston undercrown cooling nozzles to insure proper piston cooling (as outlined in the Mack Service Manual).

**NOTE 1:** Proper oil pressure is also important to assure sufficient oil volume for proper cooling.

### 8.5.2 *New Parts*

Use test parts on a first-in/first-out basis. Install the following new parts for each rebuild, see Table A2.1, Annex A2 for part numbers:

8.5.2.1 Cylinder liners

8.5.2.2 Pistons



- 8.5.2.3 Piston rings
- 8.5.2.4 Overhaul gasket set
- 8.5.2.5 Oil filters
- 8.5.2.6 Engine coolant conditioner
- 8.5.2.7 Primary fuel filter
- 8.5.2.8 Secondary fuel filter
- 8.5.2.9 Valve stem seals and keys
- 8.5.2.10 Valve guides and inserts
- 8.5.2.11 Valves
- 8.5.2.12 Connecting rod bearings
- 8.5.2.13 Main bearings
- 8.5.2.14 Thrust washers

## 8.6 *Measurements*

### 8.6.1 *Calibrations*

8.6.1.1 Calibrate thermocouples, pressure gages, speed and fuel flow measuring equipment prior to each reference oil test or at any time readout data indicates a need. Conduct calibrations with at least two points that bracket the normal operating range. Make these calibrations part of the laboratory record. During calibration, connect leads, hoses and read-out systems in the normally used manner and calibrate with necessary standards. For controlled temperatures, immerse thermocouples in calibration baths. Calibrate standards with instruments traceable to the National Institute of Standards and Technology on a yearly basis.

### 8.6.2 *Temperatures*

#### 8.6.2.1 *General*

Measure temperatures with thermocouples and conventional readout equipment or equivalent. For temperatures in the 0 - 150 °C (32 - 300 °F) range, calibrate temperature measuring systems to  $\pm 0.5$  °C for at least two temperatures that bracket the normal operating range. Insert all thermocouples so that the tips are located midstream of the flow unless otherwise indicated.

#### 8.6.2.2 *Ambient Air*

Locate thermocouple in a convenient, well-ventilated position between 2 and 3 m (approximately 6 and 10 ft) from the engine and hot accessories.

#### 8.6.2.3 *Coolant*

Locate the coolant-out thermocouple in the water manifold prior to the thermostat housing. Locate in center of water stream. Refer to Fig. A1.6, Annex A1. Locate the coolant-in thermocouple anywhere between the heat exchanger and the coolant pump inlet (upstream of the junction with the EGR coolant return). Refer to Fig. A1.7, Annex A1.

#### 8.6.2.4 *Oil Gallery*

Locate thermocouple at the center port on the filter housing. Insertion depth shall be 98 mm (3.875 in.) Refer to Fig. A1.8, Annex A1.

#### 8.6.2.5 *Oil Sump Temperature*

Using a front sump oil pan configuration, locate thermocouple on the exhaust side of the oil pan, 127 mm (5 in.) from the front and 178 mm (7 in.) from the top of the pan. Thermocouple length shall be 4in. Refer to Fig. A1.4, Annex A1.

8.6.2.6 *Intake Air Temperature*

Locate the intake air thermocouple in center of air stream at the turbocharger inlet as shown in Fig. A1.9, Annex A1. The temperature thermocouple is to be approximately 102 mm (4 in.) upstream of the compressor inlet connection. It is not necessary to control intake air humidity, but measurements are required.

8.6.2.7 *Fuel In*

Locate thermocouple at the fitting on the outlet side of the fuel transfer pump as shown in Fig. A1.10, Annex A1.

8.6.2.8 *Pre-Turbine Exhaust*

Locate one thermocouple in each side of exhaust manifold section, see Fig. A1.11, Annex A1. The thermocouple shall be downstream of the pre-turbine exhaust pressure sensor.

8.6.2.9 *Exhaust Tailpipe*

Locate thermocouple in exhaust pipe downstream of turbine according to Fig. A1.12, Annex A1.

8.6.2.10 *Intake Manifold*

Locate thermocouple at tapped fitting on intake air manifold as shown in Fig. A1.13, Annex A1.

8.6.2.11 *EGR Cooler Inlet*

Distinct EGR cooler inlet temperature measurements are not necessary. Use the pre-turbine exhaust temperatures instead (refer to Section 8.6.2.8).

8.6.2.12 *EGR Cooler Outlet*

Locate thermocouple as shown in Fig A1.14, Annex A1.

8.6.2.13 *EGR Pre-Venturi*

Locate thermocouple as shown in Fig. A1.15, Annex A1. The EGR pre-venturi thermocouple shall be downstream of the EGR pre-venturi pressure sensor pickup.

8.6.2.14 *Additional*

Monitor any additional temperatures that the test lab regards as helpful in providing a consistent test procedure.

8.6.3 *Pressures*

Pressure measurements, sensors, and sensor calibrations shall conform to RR: D02-1218 "Instrumentation Task Force Report to the ASTM Technical Guidance Committee".

8.6.3.1 *Before Oil Filter*

Locate pickup at tapped hole on oil cooler fitting, see Fig. A1.16, Annex A1.

8.6.3.2 *After Oil Filter (Main Oil Gallery)*

Locate pickup at the left port of the filter housing. Refer to Fig. A1.8, Annex A1.

**NOTE 2:** The E7 engine has only one oil gallery which serves as both a main gallery and piston cooling gallery.

- 8.6.3.3 *Pre-Turbine Exhaust*  
Locate pickup in each side of exhaust manifold section (tap shall be upstream of the pre-turbine temperature thermocouple), see Fig. A1.11, Annex A1. This measurement is not mandatory, but it is recommended for diagnostic and safety purposes.
- 8.6.3.4 *Intake Manifold (Air Boost)*  
Take measurement at tapped fitting provided on intake manifold as illustrated in Fig. A1.17, Annex A1.
- 8.6.3.5 *Intake Air Pressure (Intake Air Restriction)*  
Measure with a Keil Probe (p/n KDF-8-W required) located approximately 203 mm (8 in.) upstream of the compressor inlet (see Fig. A1.9, Annex A1). The probes may be obtained from the supplier shown in A2.11.
- 8.6.3.6 *Exhaust Back*  
Locate pickup in exhaust pipe after turbocharger in center of exhaust stream. Measure exhaust back pressure in a straight section of pipe, 30.5 - 40.6 cm (12 - 16 in.) downstream of the turbo with a pressure tap hole as shown in Fig. A1.12, Annex A1.
- 8.6.3.7 *Crankcase Pressure*  
Locate pickup at any location in the auxiliary oil system vent line, such as between the dipstick tube fitting and the top of the auxiliary oil sump bucket.
- 8.6.3.8 *Compressor Discharge*  
Locate pickup within 15.2 cm (6 in.) of the second compressor.
- 8.6.3.9 *Coolant System*  
Locate pickup at the top of the coolant system expansion tank.
- 8.6.3.10 *Barometric Pressure*  
Locate barometer approximately 1.2 m (4 ft) above ground level in convenient location in the lab.
- 8.6.3.11 *EGR Pre-Venturi Pressure*  
Locate pickup as shown in Fig. A1.15, Annex A1. The EGR pre-venturi pressure pickup shall be upstream of the EGR pre-venturi temperature thermocouple.
- 8.6.4 *Carbon Dioxide Sensors*  
Locate the intake probe as shown in Fig. A1.8, Annex A1. Locate the exhaust probe as shown in Fig. A1.12, Annex A1.
- 8.6.5 *Engine Blowby*
- 8.6.5.1 Connect the metering instrument to the filter element canister on the engine front cover.
- 8.6.6 *Fuel Consumption Measurements*
- 8.6.6.1 Place the measuring equipment in the fuel line before the primary fuel filter. Install the primary fuel filter before the fuel transfer pump and install the secondary filter before the unit injection pumps. *Fuel return lines shall never be plugged. Accurate fuel consumption measurements require proper accounting of return fuel.*
- 8.6.7 *Humidity*

8.6.7.1 Place the measurement equipment between the inlet air filter and compressor in such a manner as not to affect temperature and pressure measurements. Do not condition the intake air downstream of the humidity sensor. Report humidity on the appropriate form.

8.7 *System Time Responses*

8.7.1 The maximum allowable system time responses are shown in Table 1. Determine system time responses in accordance with the Data Acquisition and Control Automation II (DACA II) Task Force Report<sup>17</sup>.

**TABLE 1  
MAXIMUM ALLOWABLE SYSTEM TIME RESPONSES**

Measurement Type	Time Response (s)
Speed	2.0
Temperature	3.0
Pressure	3.0
Flow	45.0

**9. PROCEDURE**

9.1 *Pretest Procedure*

9.1.1 *Initial Oil Fill for Flush or Break-In*

9.1.1.1 The initial oil fill is 28.1 kg (62.0 lb) of test oil. Add the first 3.3 kg (7.2 lb) of fresh test oil to the oil filters (half in each filter), then turn on the auxiliary oil pumps and add an additional 24.8 kg (54.8 lb) of test oil to the engine. This oil may be added directly through the engine oil fill tube.

9.1.2 *Pretest Break-In Sequence for New Engine Builds*

9.1.2.1 For a new engine build, a break-in sequence is required. Start the engine as described in Annex A5. Run the break-in for 1 h at the test operating conditions shown in Table 2. At the end of 1 h, shut down the engine according to Annex A5. Perform a valve lash check. Drain the oil from the oil pan and auxiliary oil reservoir. Replace all oil filters. Refill the engine with test oil (refer to Section 9.1.1.1) and conduct the test in accordance with Section 9.4.

9.1.3 *Pretest Oil Flush Sequence for Existing Engine Builds*

9.1.2.1 For an existing engine build, a pretest flush sequence is required. Start the engine as described in Annex A5. Run a pretest oil flush for 30 min at the test operating conditions shown in Table 2. At the end of 30 min, shut down the engine as describe in Annex A5. Drain the oil from the oil pan and auxiliary oil reservoir. Refill the engine with oil (refer to Section 9.1.1.1) and repeat the flush sequence once. For tests on an existing engine build, a post test flush sequence as described in Section 9.4.2 should be done prior to the pretest flushes.

9.1.2.2 At the end of the second 30 min pretest flush, shut down the engine according to Annex A5. Drain the oil from the oil pan and auxiliary oil reservoir. Replace all oil filters. Refill the engine with test oil (refer to Section 9.1.1.1) and conduct the test in accordance with

Section 9.4. When performing the pre-test oil charge, do not account for any hang up oil left in the oil system.

## 9.2 *Engine Start-Ups*

9.2.1 Perform all engine start-ups according to Annex A5. Start-ups are not included as test time. Test time starts as soon as the engine returns to the test cycle. The start date and time of a test is defined as when the engine first reaches test conditions as shown in Table 2. **Warning** – Crank the engine prior to start-up to fill the engine oil passages. This practice will enhance engine durability significantly.

## 9.3 *Engine Shutdowns*

9.3.1 Perform all non-emergency shutdowns according to Annex A5. The shutdown operation does not count as test time. Record the length and reason of each shutdown on the appropriate form.

9.3.2 All operationally valid tests should not exceed 10 shutdowns. Additionally, all operationally valid tests should not exceed 150 h of downtime. Conduct an engineering review if either condition is exceeded.

## 9.4 *Test Cycle*

9.4.1 The test cycle includes a break-in or a pretest oil flush sequence (refer to Sections 9.1.2 and 9.1.3). Test operating conditions are shown in Table 2. Conduct the test by operating for 252 h at these test conditions. The test is followed by a post test oil flush sequence (refer to Section 9.4.2) unless the engine build life has been exhausted, at which point the engine is torn down for rebuild.

9.4.1.1 At any time during the test, injection timing may be changed  $\pm 3.0^\circ$  BTDC from the initial timing to ensure meeting the 96-h, 192-h, and 252-h soot windows (refer to Section 11.7).

### 9.4.2 *Post Test Oil Flush Sequence*

9.4.2.1 Within 30 min of EOT, begin the post test flush by draining the oil pan and auxiliary oil reservoir. Remove the oil filters, including the centrifugal filter. As soon as possible, install new filters, refill (refer to Section 9.1.1.1) with Bulldog EO-N Premium Plus Oil and run at test conditions (Table 2) for 30 min.

9.4.2.2 Drain the post test flush oil from the oil pan and the auxiliary oil reservoir. Flush the engine and auxiliary oil system with solvent until clean. Remove the oil pan and solvent clean and then reassemble. To remove the solvent, fill the engine with Bulldog EO-N Premium Plus oil and run the final post test oil flush for 30 min at test conditions (Table 2). Drain the oil from the oil pan and auxiliary oil reservoir. The engine is now ready for the pretest flush sequence for the next test.

### 9.5.2 *Operational Validity*

9.5.2.1 Determine operational validity according to Annex A3.

**TABLE 2  
TEST CONDITIONS**

Parameters	Limits
	Test
Time, h	252
Injection Timing, °BTDC	Variable <sup>A</sup>
<b>CONTROLLED PARAMETERS<sup>B</sup></b>	
Speed, r/min	1800
Fuel Flow, kg/h (lb/h)	53.5 (118.0)
Intake CO <sub>2</sub> Level, %	1.5 +/- 0.05
Inlet Manifold Temp., °C (°F)	70 (158)
Coolant Out Temp., °C (°F)	66 (150)
Fuel In Temp., °C (°F)	40 (104)
Oil Gallery Temp., °C (°F)	88 (190)
Intake Air Temp., °C (°F)	25 (77)
<b>RANGED PARAMETERS<sup>C</sup></b>	
Inlet Air Restriction, kPa (in. H <sub>2</sub> O)	3.5 – 4.0 (14 - 16)
Inlet Manifold Pressure, kPa (in. Hg)	Range to be determined
Exhaust Back Pressure, kPa (in. H <sub>2</sub> O)	2.7 – 3.5 (11 - 14)
Crankcase Pressure, kPa (in. H <sub>2</sub> O)	0.25 – 0.75 (1 – 3)
<b>UNCONTROLLED PARAMETERS</b>	
Power, kW (bhp)	~257 (~345)
Torque, N•m (lbf•ft) <sup>D</sup>	Record <sup>D</sup>
Exhaust Temp., °C (°F)	
Pre-turbine	Record
Tailpipe	Record
Oil Sump Temp., °C (°F)	Record
Coolant In Temp., °C (°F)	Record
EGR Cooler Inlet Temp. Front, °C (°F)	Record
EGR Cooler Outlet Temp. Rear, °C (°F)	Record
EGR Pre-Venturi Temp., °C (°F)	Record
Inlet Air Dew Point, °C (°F)	Record
Inlet Air Humidity, g/kg (gr/lb)	Record
Blowby, L/min (ft <sup>3</sup> /min)	Record
Pre-turbine Exhaust Pressure, kPa (in. Hg)	Record
Main Gallery Oil Pressure, kPa (psi)	Record
Oil Filter ΔP, kPa (psi)	Not to exceed 207 (30) <sup>E</sup>

A: For pretest and post test oil flushes, injection timing shall be **tbd**° BTDC.

B: All control parameters shall be targeted at the mean indicated.

C: All ranged parameters shall fall within the specified ranges.

D: At 98.2 kPa (29 in. Hg) and 29.5 °C (85 °F) dry air.

E: If oil filter ΔP exceeds 207 kPa (30 psi), change the two full flow filters. If the filters are changed, attempt to recover as much oil as possible by draining the filters. No new oil is to be added. The test report shall indicate if the filters are changed.

## 9.5 Oil Samples

9.5.1 Take 120-mL (4-oz) oil samples at every 12-h interval. Take the EOT oil sample within 30 min of test completion. Obtain oil samples from the pre-filter pressure port, refer to Fig. A1.16, Annex A1. This can be done by installing a tee fitting, a small petcock valve and 254 to 305 mm (10 to 12 in) of No. 4 Aeroquip line from which the sample is taken. Prior to each sample, take a 240-ml (8-oz) purge. After sampling has been completed, be sure to return the purge to the engine.

## 9.6 Oil Weight Measurements

9.6.1 Record the oil weight every 6 min and compute the oil consumption (refer to Section 10.3) from these readings.

## 9.7 Fuel Samples

9.7.1 Take fuel samples (two 1-L [1-qt] samples) prior to the start of test and at EOT.

9.8 *Periodic Measurements*

9.8.1 Make measurements at 6 min intervals on the parameters listed in Section 9.9.2 and record statistics on the appropriate form. Automatic data acquisition is required. Recorded values shall have minimum resolution as shown in Table 3. Characterize the procedure used to calculate the data averages on the appropriate form.

**TABLE 3  
MINIMUM RESOLUTION OF RECORDED MEASUREMENTS**

PARAMETER	Record Data to Nearest	PARAMETER	Record Data to Nearest
Speed	1 r/min	Blowby	1 L/min
Fuel Flow	0.1 kg/h	Inlet Air Dew Point	1 °C
Coolant Temperatures	0.1 °C	Oil Temperatures	0.1 °C
Fuel In Temperature	0.1 °C	Exhaust Temperatures	1 °C
Intake Air Temperature	0.1 °C	EGR Temperatures	1 °C
Intake Manifold Temperature	0.1 °C	Oil Pressures	1 kPa
Exhaust Back Pressure	0.1 kPa	Crankcase Pressure	0.1 kPa
Inlet Air Restriction	0.1 kPa	Intake Manifold Pressure	1 kPa
Torque	1 N•m	Oil Weight	0.001 kg
Power	1 kW		
Humidity	0.1 g/kg		

9.8.2 Parameters

- 9.8.2.1 Speed, r/min
- 9.8.2.2 Torque, N•m (lbf•ft)
- 9.8.2.3 Oil Gallery Temperature, °C (°F)
- 9.8.2.4 Oil Sump Temperature, °C (°F)
- 9.8.2.5 Coolant Out Temperature, °C (°F)
- 9.8.2.6 Coolant In Temperature, °C (°F)
- 9.8.2.7 Intake Air Temperature, °C (°F)
- 9.8.2.8 Intake Manifold Temperature, °C (°F)
- 9.8.2.9 Intake Manifold Pressure, kPa (in. Hg)
- 9.8.2.10 Fuel Flow, s/kg or kg/h (s/lb or lb/h)
- 9.8.2.11 Fuel Inlet Temperature, °C (°F)
- 9.8.2.12 Tailpipe Exhaust Back Pressure, kPa (in. H<sub>2</sub>O)
- 9.8.2.13 Before Filter Oil Pressure, kPa (psi)
- 9.8.2.14 Main Gallery Oil Pressure, kPa (psi)
- 9.8.2.15 Crankcase Pressure, kPa (in. H<sub>2</sub>O)
- 9.8.2.16 Pre-Turbine Exhaust Temperature, Front Manifold, °C (°F)
- 9.8.2.17 Pre-Turbine Exhaust Temperature, Rear Manifold, °C (°F)
- 9.8.2.18 Inlet Air Restriction, kPa (in. H<sub>2</sub>O)
- 9.8.2.19 Tailpipe Exhaust Temperature, °C (°F)
- 9.8.2.20 Crankcase Blowby, L/min (ft<sup>3</sup>/min) (see Section 9.10)
- 9.8.2.21 Pre-Turbine Exhaust Pressure, Front Manifold, kPa (in. Hg)
- 9.8.2.22 Pre-Turbine Exhaust Pressure, Rear Manifold, kPa (in. Hg)
- 9.8.2.23 Inlet Air Humidity, g/kg (grains/lb)
- 9.8.2.24 EGR Cooler Outlet Temperature, °C (°F)
- 9.8.2.25 EGR Pre-Venturi Temperature, °C (°F)
- 9.8.2.26 Inlet Air Dew Point, °C (°F)
- 9.8.2.27 Oil Weight, kg (lbf)

9.8.3 *Carbon Dioxide Measurements*

9.8.3.1 Measure intake and exhaust carbon dioxide levels every four h. Calibrate the measurement equipment with span gases prior to each measurement.

9.9 *Blowby*

9.9.1 Record the crankcase blowby on the appropriate form. Take care to prevent oil traps from occurring in the blowby line at any time during operation.

9.10 *Centrifugal Oil Filter Mass Gain*

Prior to the start of test, determine the mass of the centrifugal oil filter canister. At EOT, remove the centrifugal oil filter canister from the engine and drain upside down for 30 min. After draining, determine the mass of the canister and record on the appropriate form. Determine the centrifugal oil filter mass gain for each test.

9.11 *Oil Filter  $\Delta P$  Calculation*

9.11.1 The reported oil filter  $\Delta P$  is the maximum oil filter  $\Delta P$  that occurs as a result of the test. Calculate the oil filter  $\Delta P$  as follows:

$$\Delta P \text{ Increase} = \Delta P_{\text{max}} - \Delta P_{\text{initial}} \quad (1)$$

where:  $\Delta P_{\text{max}}$  = the maximum  $\Delta P$  across the oil filter.

$\Delta P_{\text{initial}}$  = the  $\Delta P$  across the oil filter at the start of test conditions.

If an oil filter change is made, add the oil filter  $\Delta P$  value obtained after the filter change to the oil filter  $\Delta P$  obtained prior to the filter change. If a shutdown occurs, add the oil filter  $\Delta P$  value obtained after the shutdown to the oil filter  $\Delta P$  obtained prior to the shutdown. Change the oil filter if the filter pressure differential (not the  $\Delta P$  Increase) exceeds 207 kPa (30 psi). Report oil filter  $\Delta P$  Increase on the appropriate form.

## 10. INSPECTION OF ENGINE, FUEL, AND OIL

10.1 *Oil Inspection*

10.1.1 Analyze each oil sample for viscosity at 100 °C (212 °F) according to Test Method D 5967, Annex A3. Determine viscosity increase using the 90-pass DIN shear viscosity (refer to Section 10.1.6) as the minimum viscosity. To maintain accuracy and precision conduct all viscosity measurements at a TMC-calibrated laboratory.

10.1.2 Analyze each oil sample for soot content according to Test Method D 5967, Annex A4. To maintain accuracy and precision conduct all soot measurements at a TMC-calibrated laboratory. Report soot to two decimals.

10.1.3 Every 24 h, starting with the 12-h oil sample and including new and EOT samples, determine base number according to Test Method D 4739; determine acid number according to Test Method D 664; determine oxidation using integrated IR.

10.1.4 Every 24 h, starting with the 24-h oil sample and including new and EOT samples, determine iron, lead, copper, chromium, aluminum, silicon, tin, and sodium levels according to Test Method D 5185.

10.1.5 Every 24 h, starting with the new oil sample through 120-h oil sample, and then every 12-h sample thereafter through EOT, determine rotational viscosity at 100° C (increasing



and decreasing) and rate index (increasing and decreasing) according to **Rotational Viscosity of Heavy Duty Diesel Drain Oils at 100° C (D number not yet assigned)**.

- 10.1.6 For the new oil sample only, determine the 30-pass DIN shear viscosity according to Test Method D 6278. Also for the new oil sample, determine the 90-pass DIN shear viscosity.
- 10.1.7 For the 180-h and EOT oil samples, determine MRV viscosity at -20° C according to D 6896. As part of the MRV measurement procedure, be sure to prepare the sample in accordance with Section A4.3, Annex A4 of D 5967.
- 10.1.8 For the 96-h, 192-h, and EOT oil samples, determine fuel dilution according to D 3524.
- 10.1.9 Conduct all oil analyses as soon as possible after sampling.

## 10.2 *Fuel Inspections*

- 10.2.1 Use fuel purchase inspection records to insure conformance to the specifications listed in Table 1 for the last batch of fuel used during the test. In addition, perform the following inspections on new (0 h) and EOT (252 h) fuel samples:

API Gravity at 15.6 °C (60 °F), Test Method D 287 or D 4052  
Total Sulfur, % Weight, Test Method D 129 or D 2622  
Use one 1-L (1-qt) sample for inspections.

## 10.3 *Oil Consumption Calculation*

- 10.3.1 Using the 6 min oil weight measurements (Section 9.7), determine the oil consumption in g/h by performing linear regression on the data starting from 25 h and ending at 252 h or when the auxiliary oil sump runs dry. The oil consumption is the slope of the regression line.
  - 10.3.1.1 Following any shutdowns, exclude 1 h of oil weight data from the regression to account for the stabilizing of the oil scale.
  - 10.3.1.2 The auxiliary oil sump is considered to have run dry when the oil weight curve shows a significant flattening which indicates that the oil weight is no longer decreasing.
  - 10.3.1.3 Report the oil consumption for the test on the appropriate form. The operational validity requirement for oil consumption is shown in Sections 11.7.1.

## **11. Laboratory and Engine Test Stand Calibration / Non-Reference Requirements**

### 11.1 *Calibration Frequency*

- 11.1.1 To maintain test consistency and severity levels, calibrate the engine and test stand at regular intervals.

### 11.2 *Calibration Reference Oils*

- 11.2.1 The reference oils used to calibrate T-11 test stands have been formulated or selected to represent specific chemical types or performance levels, or both. They can be obtained

from the TMC. The TMC will assign reference oils for calibration tests. These oils are supplied under code numbers (blind reference oils).

## 11.2.2 *Reference Oils Analysis*

11.2.2.1 Do not submit reference oils to physical or chemical analyses for identification purposes. Identifying the oils by analyses could undermine the confidentiality required to operate an effective blind reference oil system. Therefore, reference oils are supplied with the explicit understanding that they will not be subjected to analyses other than those specified within this procedure unless specifically authorized by the TMC. In such cases where analyses are authorized, supply written confirmation of the circumstances involved, the data obtained, and the name of the person authorizing the analysis to the TMC.

## 11.3 *Test Numbering*

11.3.1 Number each T-11 test to identify the test stand number, the test stand run number, engine serial number, and engine hours at the start of the test. The sequential stand run number remains unchanged for reruns of aborted, invalid, or unacceptable calibration tests. However, follow the sequential stand run number by the letter A for the first rerun, B for the second, and so forth. For calibration tests, engine hours shall be zero. For non-reference oil tests, engine hours are the test hours accumulated since last calibration. For example, 58-12A-2H0380-0 defines a test on stand 58 and stand run 12 as a calibration test that was run twice on engine 2H0380 (serial number). A test number of 58-14-2H0380-252 defines a test on stand 58 and stand run 14 as a non-reference oil test on engine 2H0380, which has run 252 hours since the last reference.

## 11.4 *New Laboratories and New Test Stands*

11.4.1 A new lab is any lab that has never previously calibrated a test stand under this test method, or has not calibrated a test stand within one year from the end of the last successful calibration test. All stands at a new laboratory are considered new stands.

11.4.2 A new stand is a test cell and support hardware which has never previously been calibrated under this test method, or has not been calibrated within a year from the end of the last successful calibration test on that stand.

11.4.3 Calibrate a new test stand in accordance with the Lubricant Test Monitoring System (LTMS)<sup>17</sup>. Generally, new test stands require two successful calibration tests. However, provisions do exist within the LTMS to allow new stands to calibrate with one test, based upon previous test experience within the laboratory.

## 11.5 *Test Stand Calibration*

11.5.1 *Test Stand Calibration* – Perform a calibration test on a reference oil assigned by the TMC after 1,512 non-reference test hours or after six months have elapsed since the completion of the last successful calibration test. An unsuccessful calibration test voids any current calibration on the test stand. A non-reference test may be started in a test stand provided at least 1 h remains in its calibration period.

11.5.2 *Test Engine Rebuild* – A newly rebuilt test engine requires a calibration test. The timing and frequency of engine rebuild is left to the discretion of the laboratory.

- 11.5.3 If non-standard tests are conducted on a calibrated test stand, the TMC may require the test stand to be recalibrated prior to running standard tests.
- 11.5.4 The TMC may shorten or extend calibrations at their discretion.
- 11.6 *Test Results*
- 11.6.1 The test result is Soot at 12 cSt Viscosity Increase (%).
- 11.7 *Reference and Non-Reference Oil Test Requirements*
- 11.7.1 All operationally valid tests shall produce a TGA soot level of  $2.75 \pm 0.25$  at 96 h,  $5.50 \pm 0.35$  at 192 h, and  $6.53 \pm 0.44$  at 228 h. Any test which misses any of these soot windows is considered operationally invalid. A lab should terminate a test that has missed any soot windows. Additionally, all operationally valid tests shall not exceed an oil consumption of 65.0 g/h.
- 11.7.1.1 Injection timing can be adjusted anytime to meet the three soot windows. However, injection timing shall not be changed after 228 h. As a guideline, injection timing should not be changed more than  $\pm 3^\circ$  from the initial injection timing.
- 11.7.2 Calibration acceptance is determined in accordance with the Lubricant Test Monitoring System<sup>18</sup> (LTMS) as administered by the TMC.
- 11.8 *Non-Reference Oil Test Result Severity Adjustments*
- 11.8.1 This test method incorporates the use of a Severity Adjustment (SA) for non-reference oil test results. A control chart technique, described in the LTMS, has been selected for identifying when a bias becomes significant Soot at 12 cSt Viscosity Increase. When calibration test results identify a significant bias, determine a SA according to LTMS. Report the SA value on Form 4, Test Results Summary, in the space for SA. Add this SA value to non-reference oil test results, and enter the adjusted result in the appropriate space. The SA remains in effect until a new SA is determined from subsequent calibration test results, or the test results indicate the bias is no longer significant. Calculate and apply SA's on a laboratory basis.

## **12. REPORT**

- 12.1 *Reporting Reference Oil Test Results*
- For reference oil tests, the standardized report form set and data dictionary for reporting test results and for summarizing operational data are required. Report forms and the Data Dictionary are available from the TMC. Fill out the report forms according to the formats shown in the Data Dictionary. When transmitting data electronically, a Header Data Dictionary shall precede the Data Dictionary. The latest version of this Header Data Dictionary can be obtained from the TMC either by ftp (internet) or by calling the Test Engineer responsible for this particular test. Round the data in accordance with Practice E 29.
- 12.1.1 During the test, if the engine is shut down or operated out of test limits, record the test hours, time, and date on the appropriate form. In addition, all prior reference oil tests that were deemed operationally or statistically invalid should be noted in the comment section.

12.1.2 When reporting reference oil test results, transmit the test data electronically by utilizing the ASTM Data Communications Committee Test Report Transmission Model (see Section 2 – Flat File Transmission Format) which is available from the TMC. Transmit the data within five working days of test completion. Mail a copy of the final test report within 30 days of test completion to:

ASTM Test Monitoring Center  
6555 Penn Avenue  
Pittsburgh, PA 15206-4489

12.2 *Deviations from Test Operational Limits*  
Report all deviations from specified test operational limits.

### 13. PRECISION AND BIAS

#### 13.1 *Precision*

13.1.1 Test precision is established on the basis of operationally valid reference oil test results monitored by the TMC.

13.1.1.1 *Intermediate Precision (formerly called repeatability) conditions* – conditions where test results are obtained with the same test method using the same oil, with changing conditions such as operators, measuring equipment, test stands, test engines, and time.

13.1.1.2 *Intermediate Precision Limit (i.p.)* – the difference between two results obtained under intermediate precision conditions that would in the long run, in the normal and correct conduct of the test method, exceed the values shown in Table 4 in only one case in twenty.

13.1.1.3 *Reproducibility Conditions* – conditions where test results are obtained with the same test method using the same test oil in different laboratories with different operators using different equipment.

13.1.1.4 *Reproducibility Limit (R)* – the difference between two results obtained under reproducibility conditions that would, in the long run, in the normal and correct conduct of the test method, exceed the values shown in Table 4 in only one case in twenty.

13.1.2 Test precision, as of September 18, 2003 is shown in Table 4.

**TABLE 4**  
**Test Precision**

Test Result	Measured Units	
	Intermediate Precision, (i.p.)	Reproducibility, (R)
Soot at 12 cSt Viscosity Increase (%)	0.62	0.62

13.1.3 The TMC will be able to update precision data as it becomes available.

#### 13.2 *Bias*

Bias is determined by applying an accepted statistical technique to reference oil test results and when a significant bias is determined, a severity adjustment is permitted for non-reference oil test results (see Section 11.8).

**14.**

**KEYWORDS**

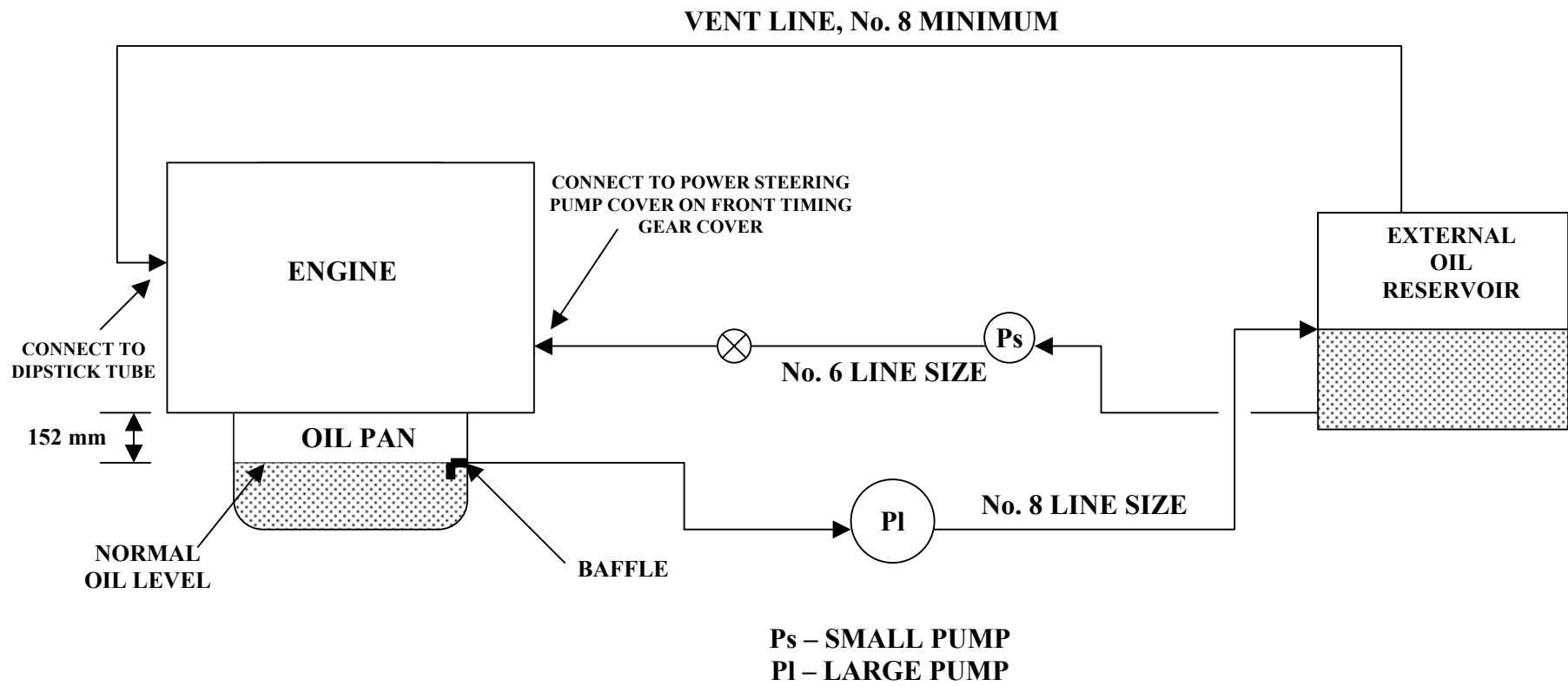
lubricants, diesel engine oil, T-11 Diesel Engine, soot, viscosity, exhaust gas recirculation



**ANNEXES**  
**(Mandatory Information)**

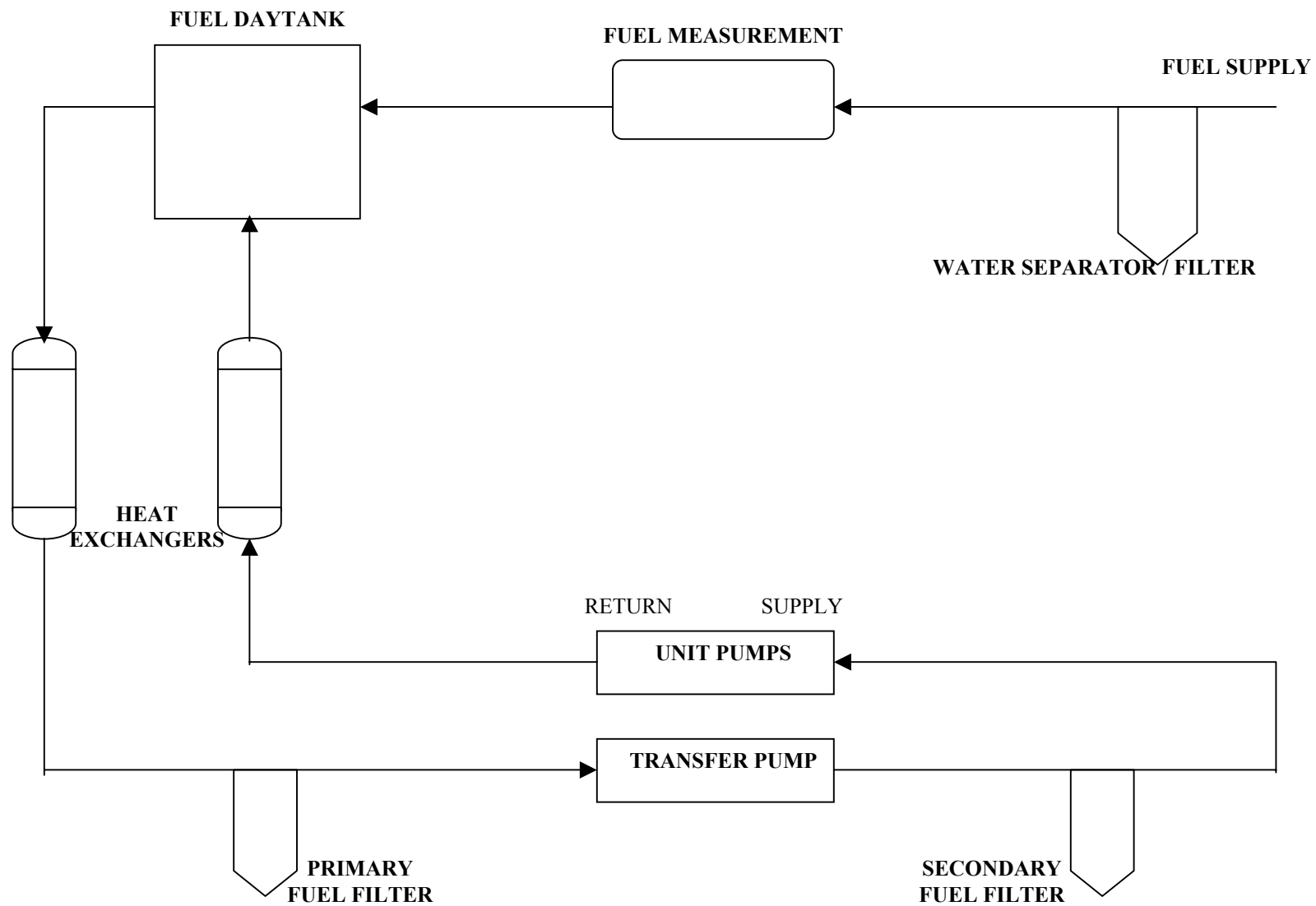
**A1. SYSTEM SCHEMATICS AND SENSOR LOCATIONS**

Properly locating the sensor devices is important to this test. The following figures indicate the sensor locations for the T-11 engine components.

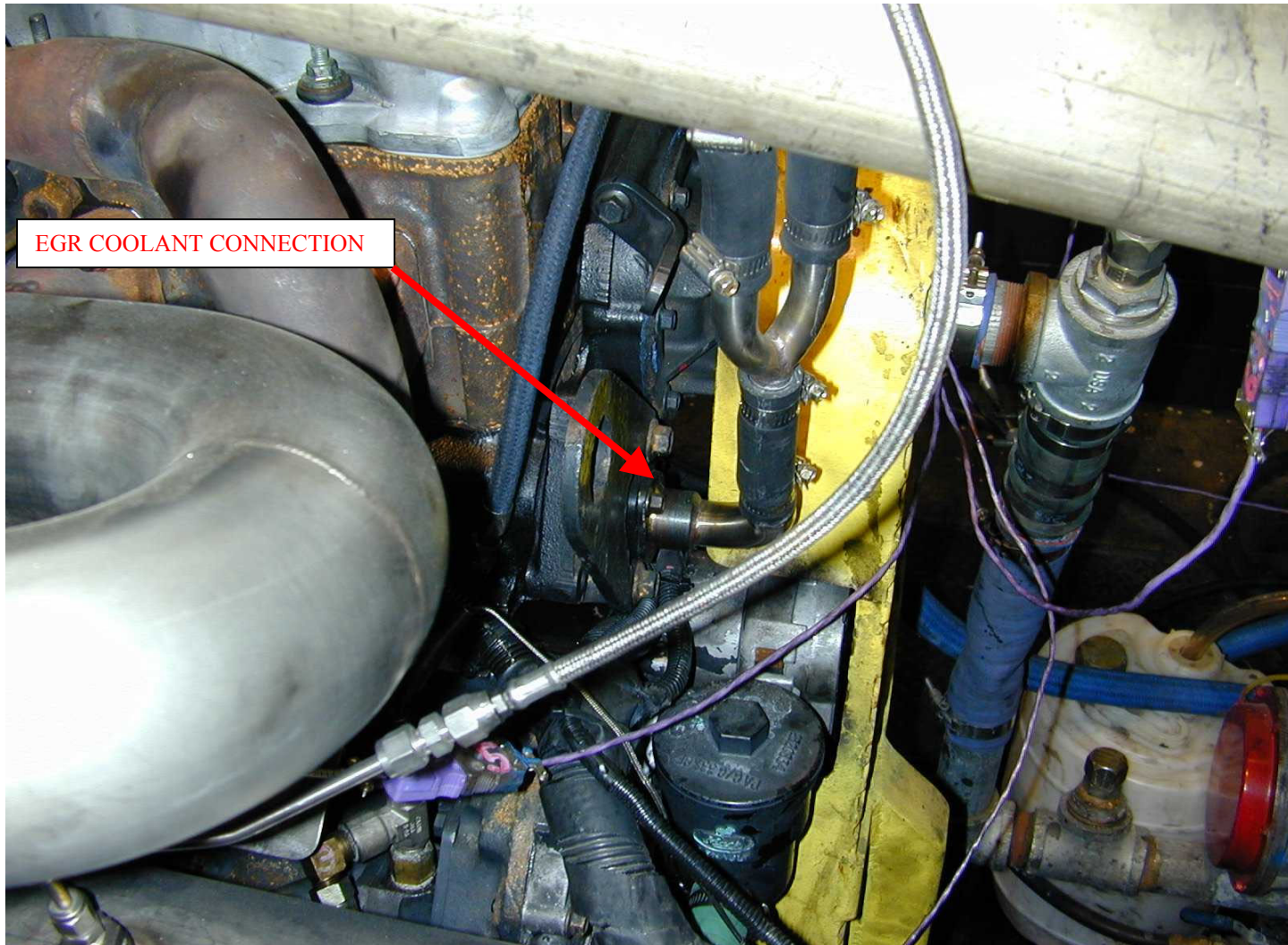


**FIG A1.1 AUXILIARY OIL SYSTEM**





**FIG. A1.2 TEST CELL FUEL SCHEMATIC**



**FIG. A1.3 COOLANT SUPPLY TO EGR COOLER**

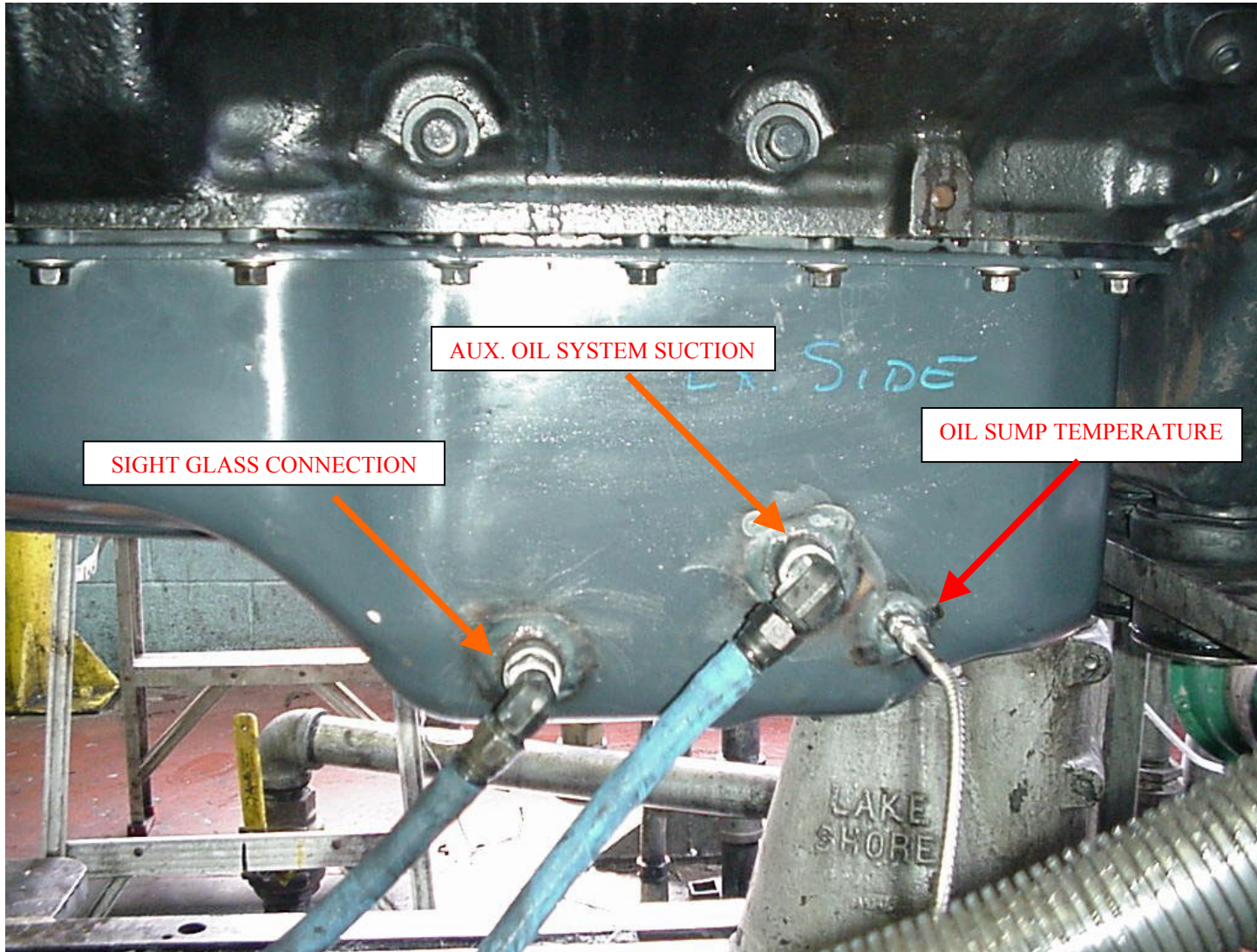
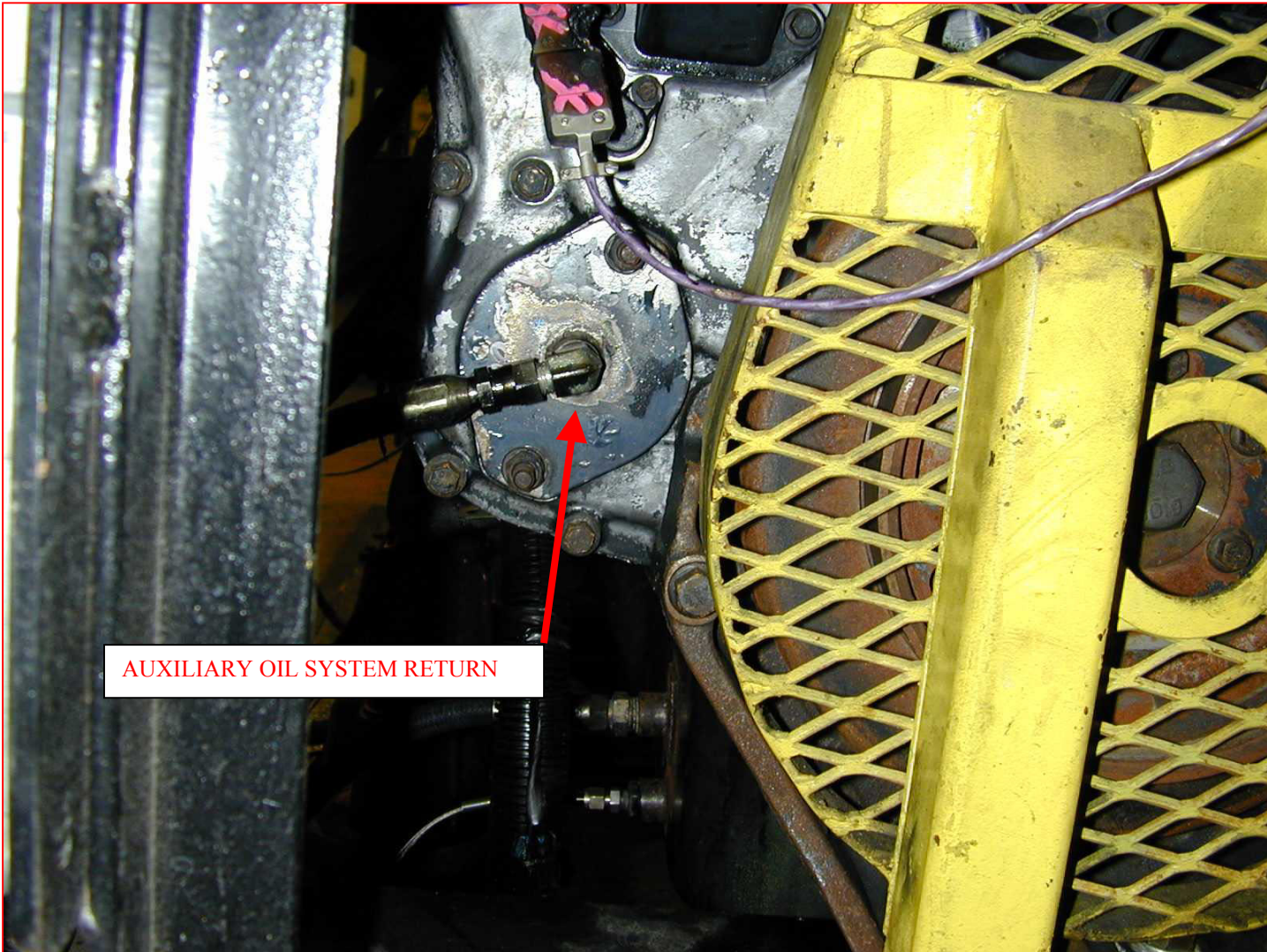
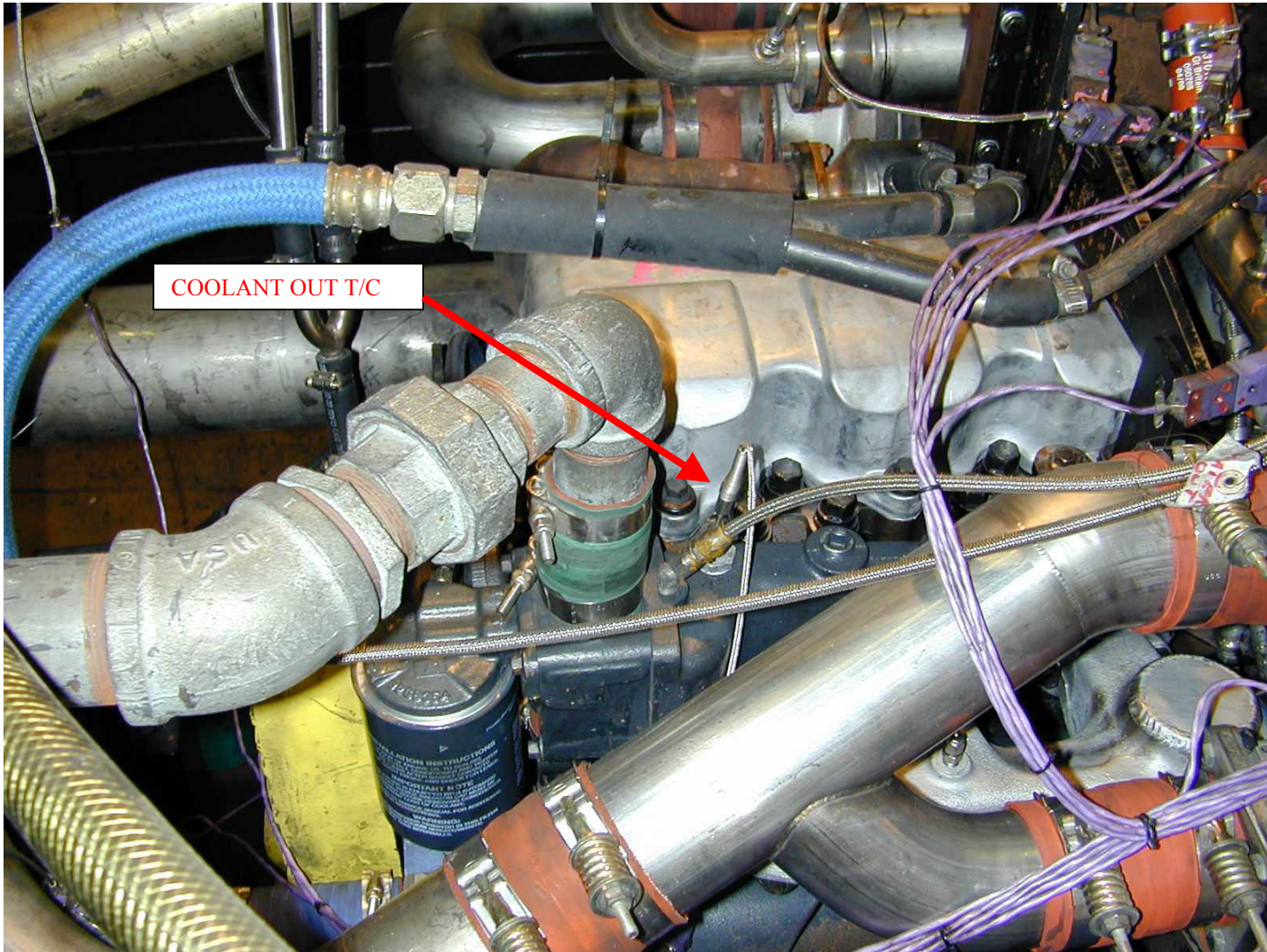


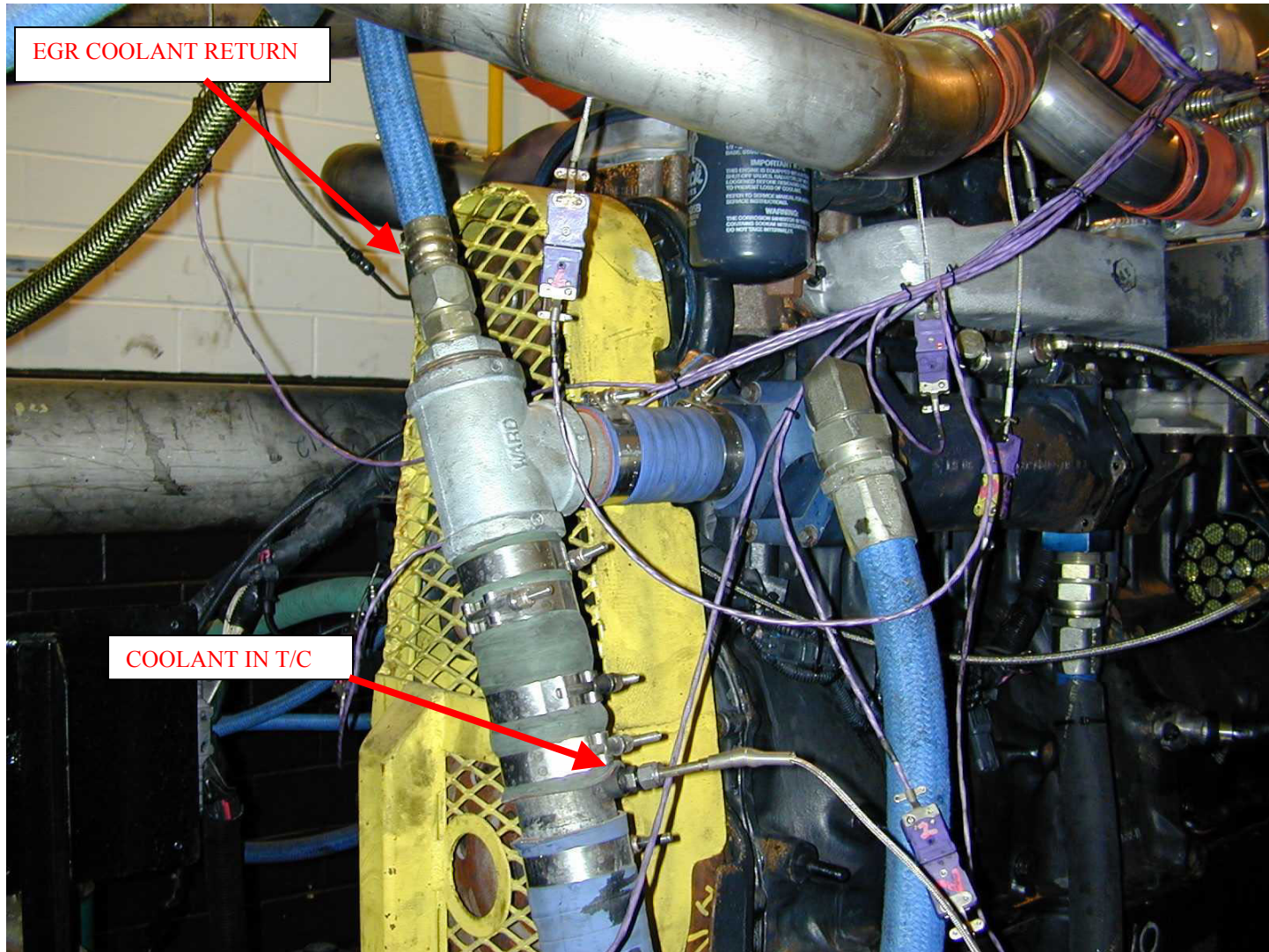
FIG. A1.4 AUXILIARY OIL SYSTEM SUCTION LINE, OIL SUMP TEMPERATURE THERMOCOUPLE, AND SIGHT GLASS CONNECTION



**FIG. A1.5 AUXILIARY OIL SYSTEM RETURN**



**FIG. A1.6 COOLANT OUT TEMPERATURE**



**FIG. A1.7 ENGINE COOLANT IN TEMPERATURE AND EGR COOLANT RETURN**

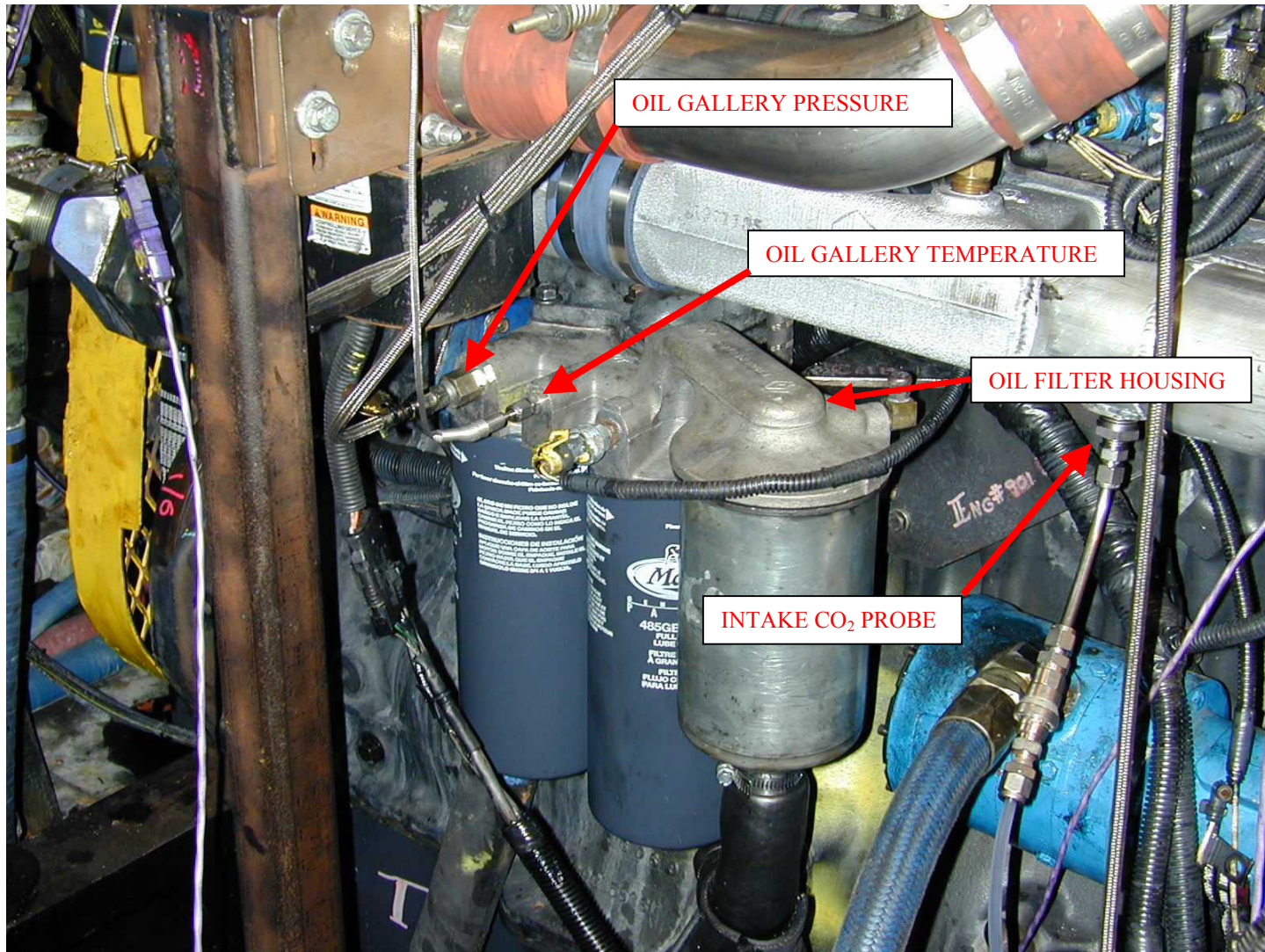
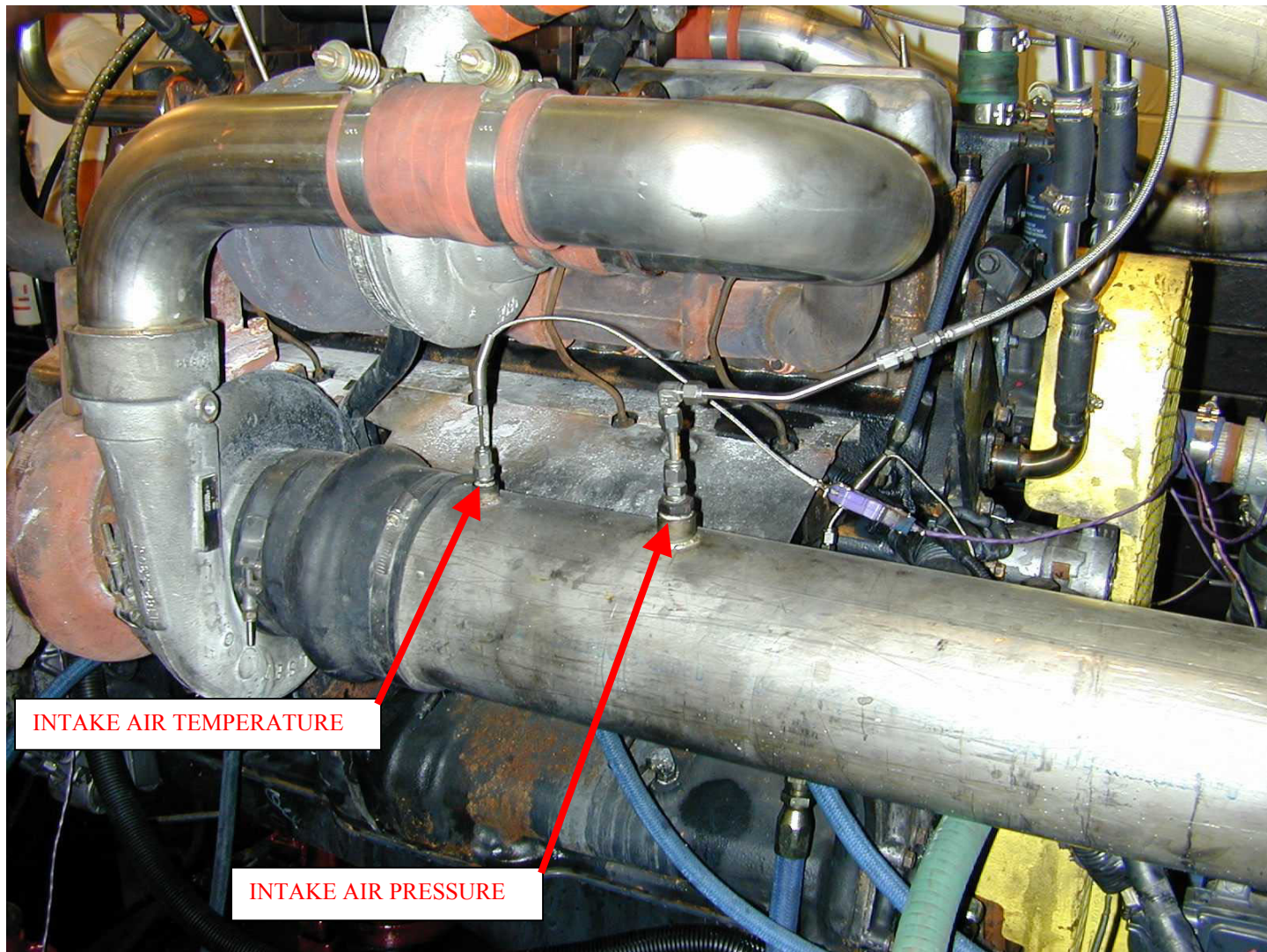
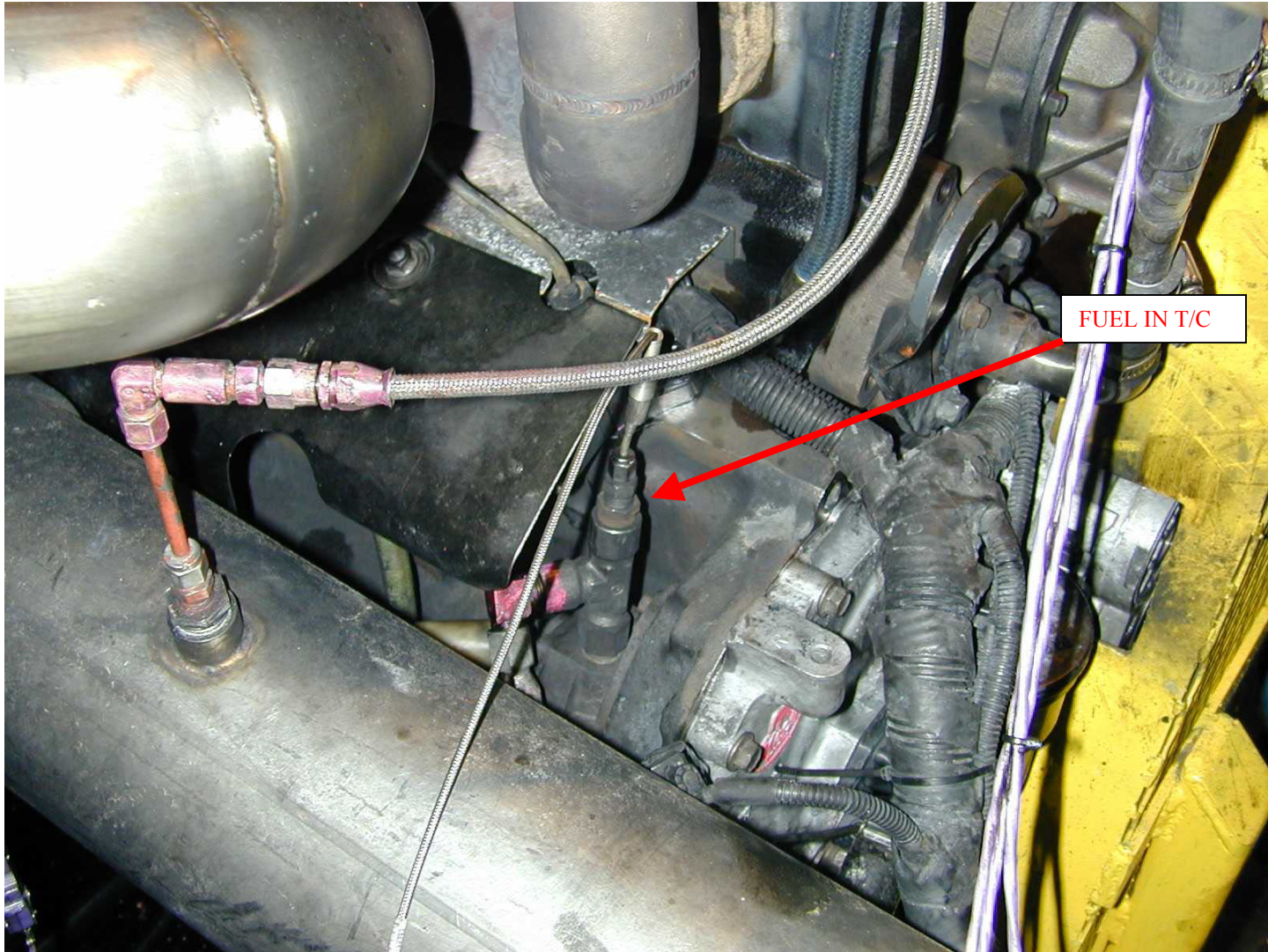


FIG. A1.8 OIL GALLERY TEMPERATURE AND PRESSURE (AFTER-FILTER PRESSURE) AND INTAKE CO<sub>2</sub> PROBE

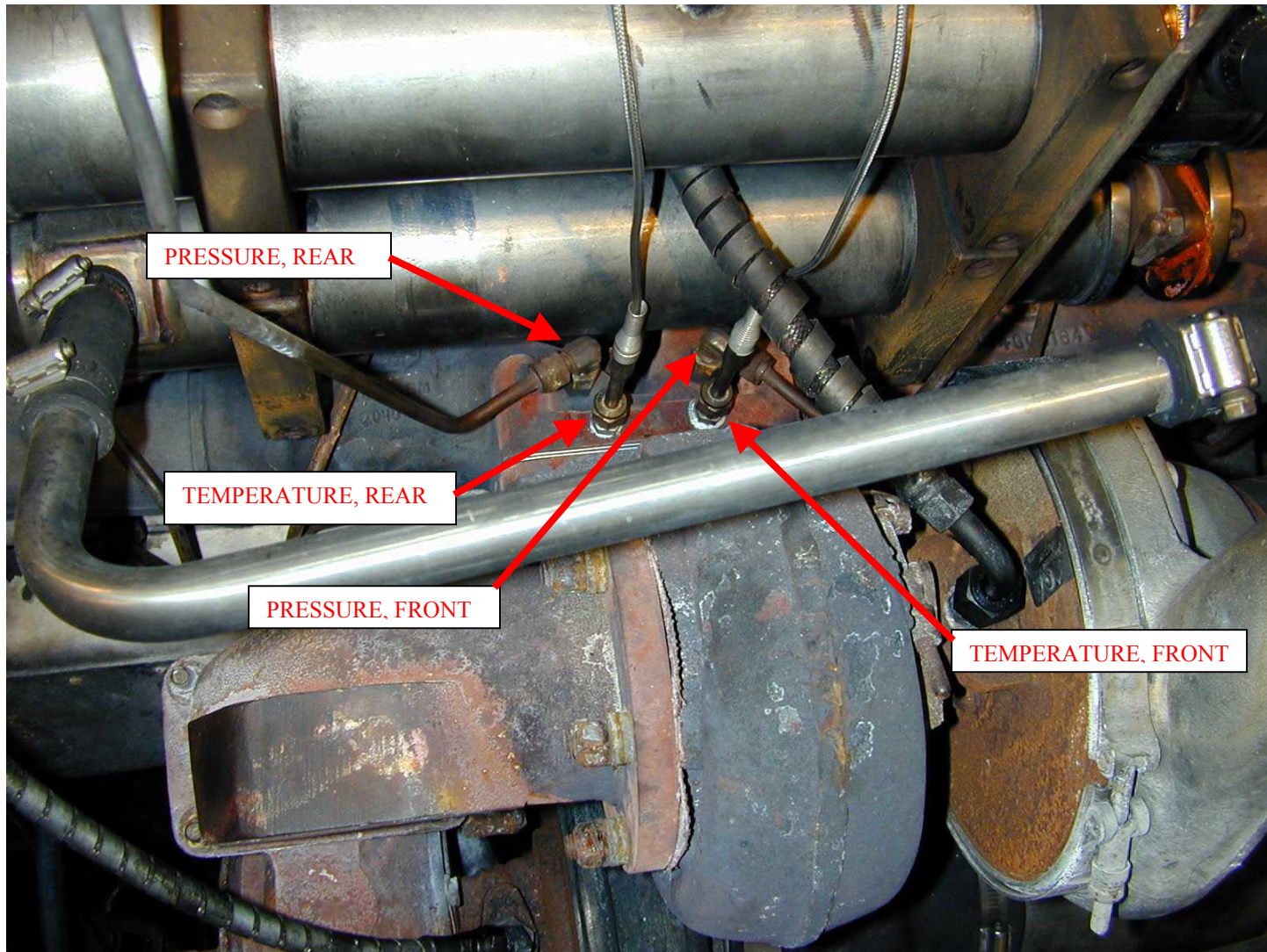


**FIG. A1.9 INTAKE AIR TEMPERATURE AND PRESSURE**

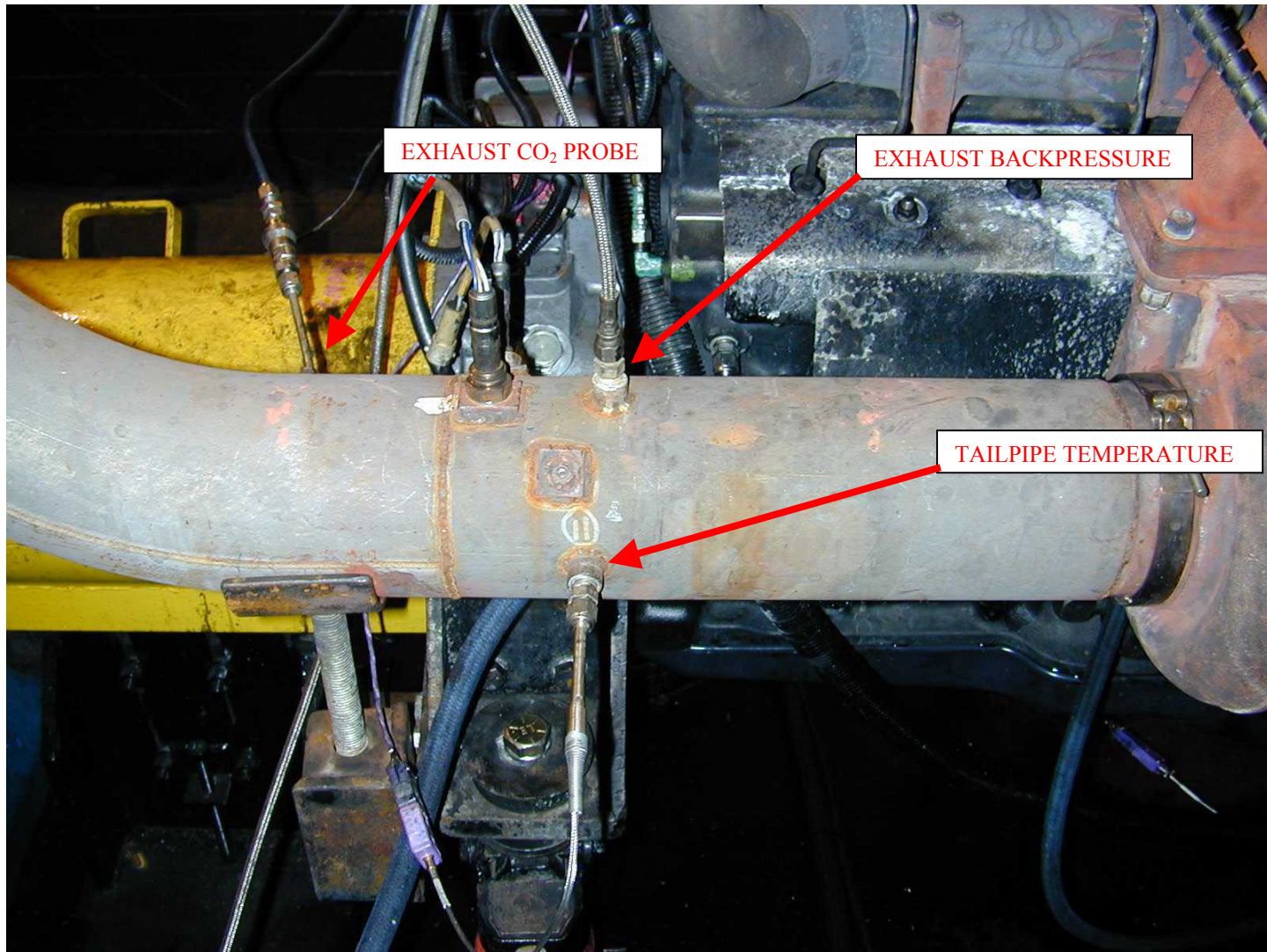




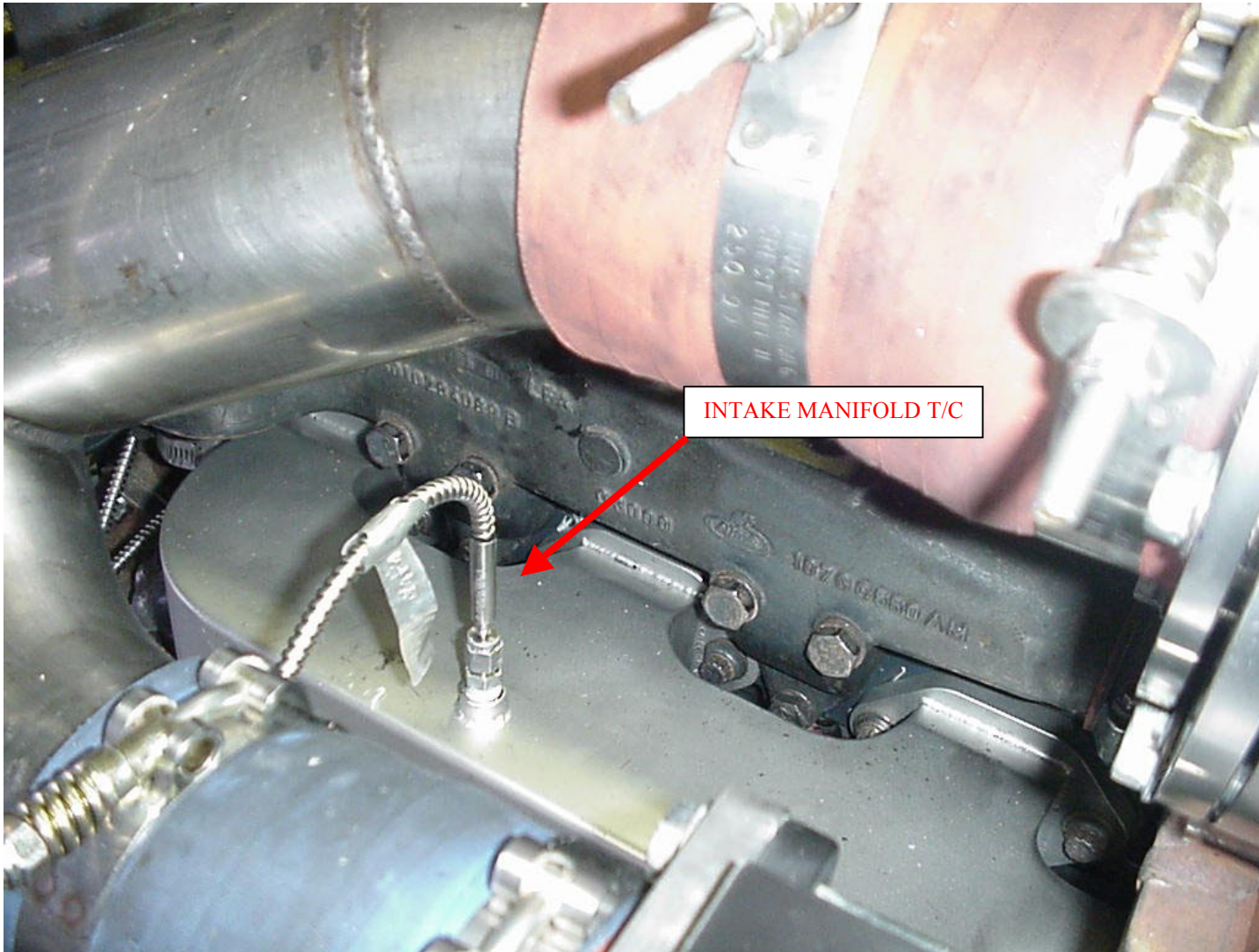
**FIG. A1.10 FUEL IN TEMPERATURE**



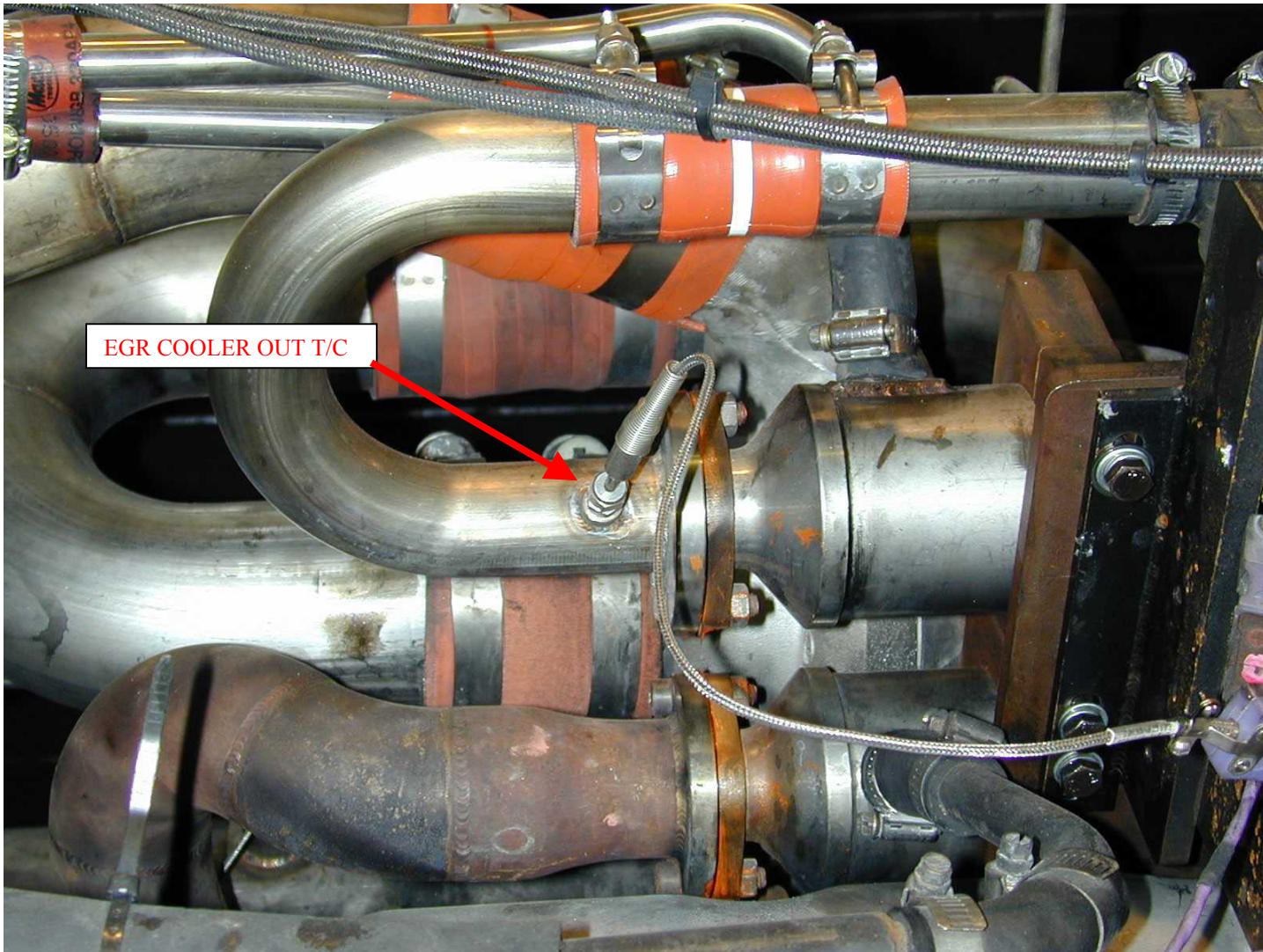
**FIG. A1.11 EXHAUST PRE-TURBINE TEMPERATURE AND PRESSURE, FRONT AND REAR**



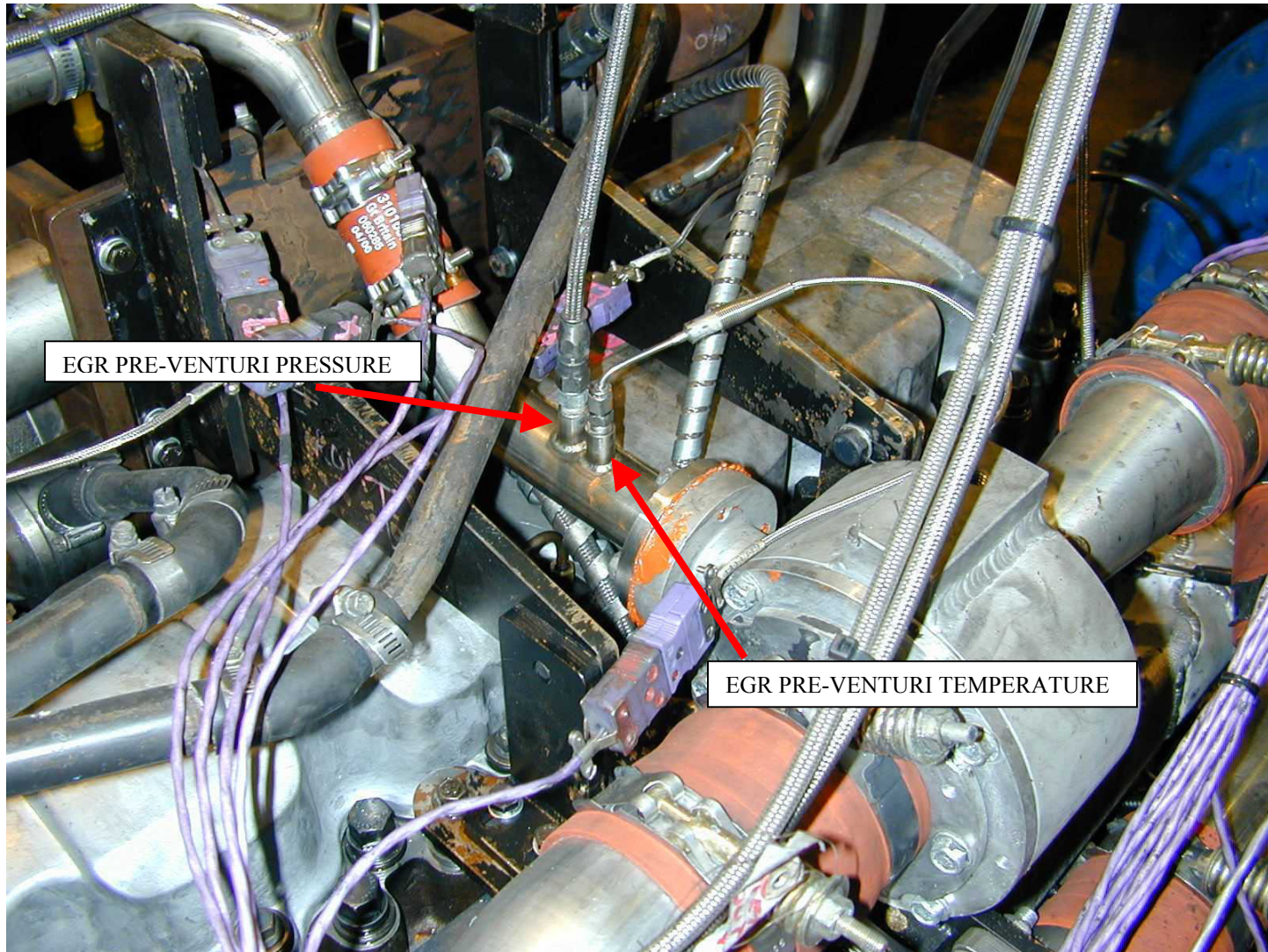
**FIG. A1.12 EXHAUST BACKPRESSURE, TAILPIPE TEMPERATURE, AND EXHAUST CO<sub>2</sub> PROBE**



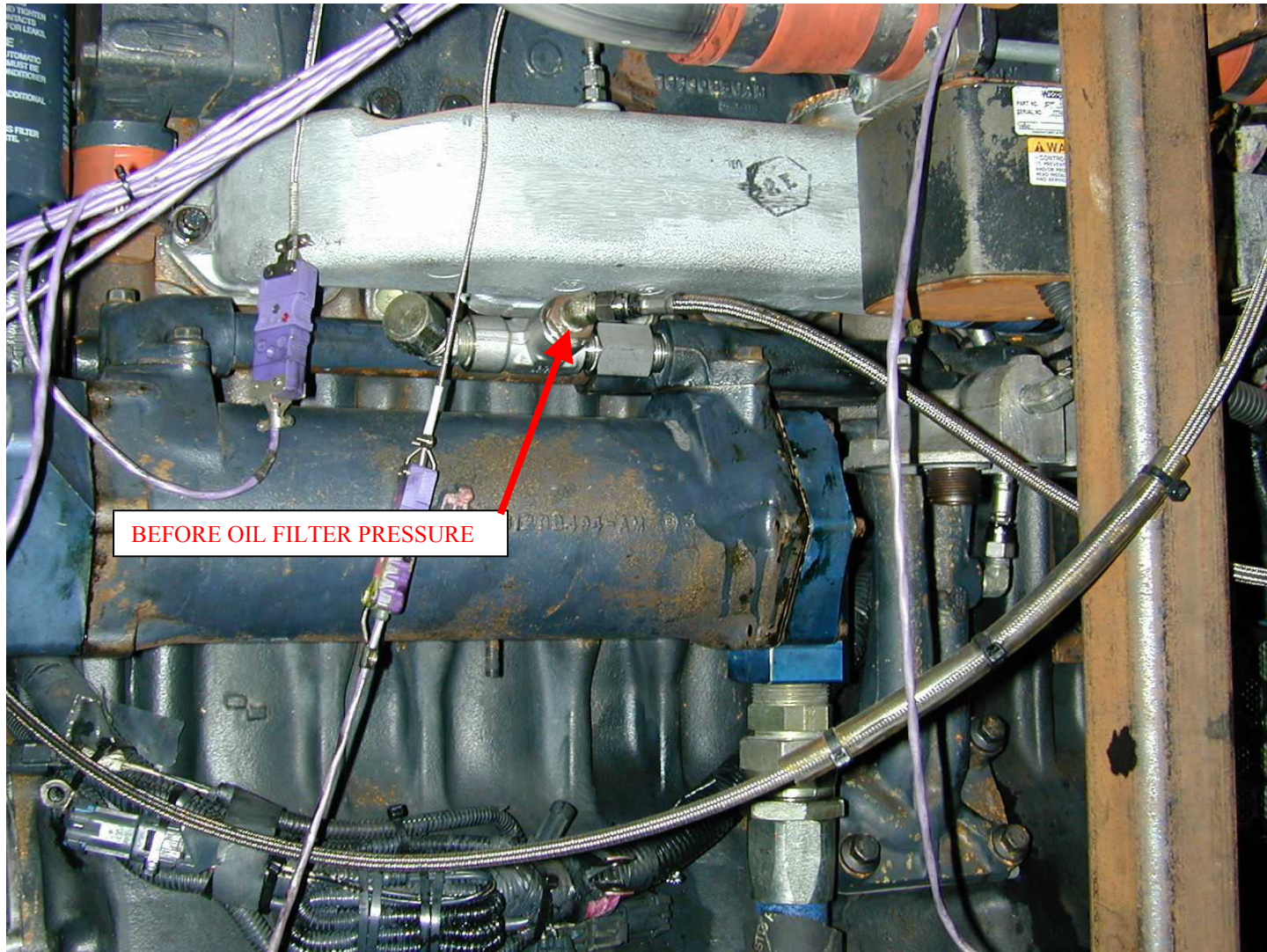
**FIG. A1.13 INTAKE MANIFOLD TEMPERATURE**



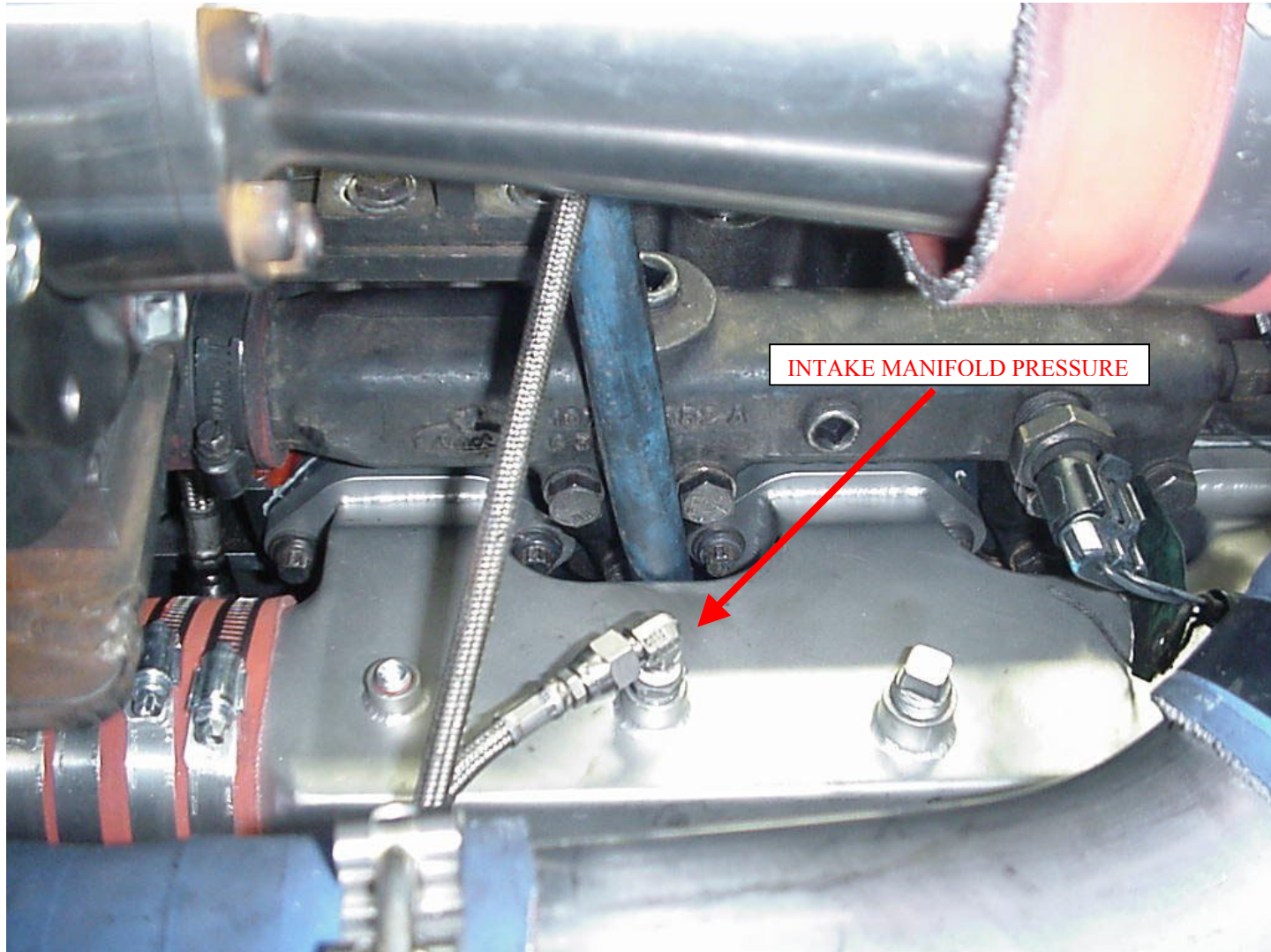
**FIG. A1.14 EGR COOLER OUT TEMPERATURE**



**FIG. A1.15 EGR PRE-VENTURI TEMPERATURE AND PRESSURE**

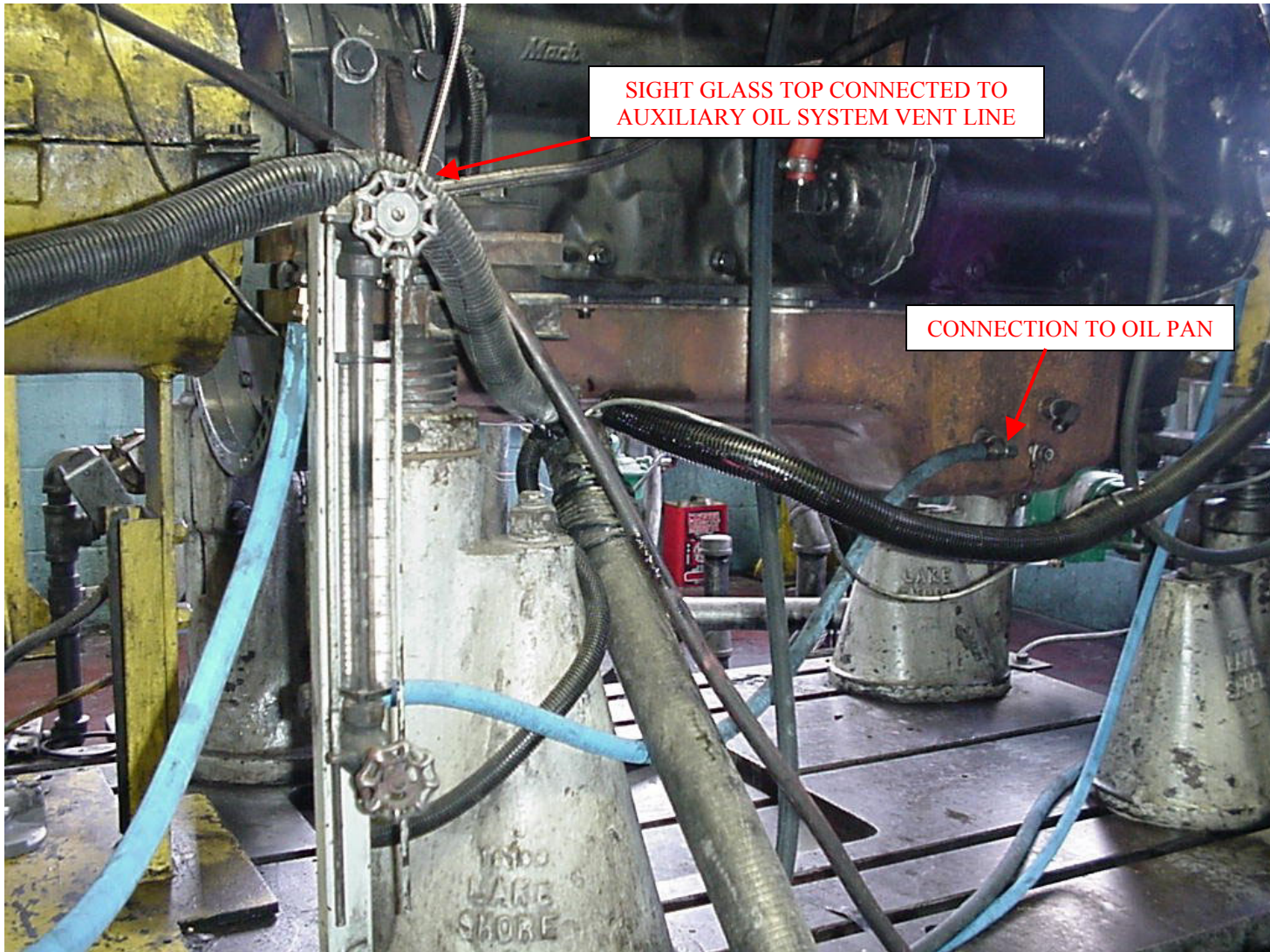


**FIG. A1.16 BEFORE OIL FILTER PRESSURE**



**FIG. A1.17 INTAKE MANIFOLD PRESSURE**





**FIGURE A1.18 SIGHT GLASS SETUP**

## A2. PROCUREMENT OF TEST MATERIALS

- A2.1 Throughout the text, references are made to necessary hardware, reagents, materials and apparatus. In many cases, for the sake of uniformity and ease of acquisition, certain suppliers are named. If substitutions are deemed appropriate for the specified suppliers, obtain permission to substitute in writing from the TMC before such substitutions will be considered to be *equivalent*. The following entries of the annex represent a consolidated listing of the ordering information necessary to complete the references found in the text.
- A2.2 The test engine (P/N 11GBA81025) and 2002 cylinder heads (P/N 732GB3494M2) are available from:  
Mack Trucks, Inc.  
13302 Pennsylvania Avenue  
Hagerstown, MD 21742
- The intake manifold, oil pump, EGR venturi unit, injector nozzles (p/n 736GB411M2), and the parts shown in Table A2.1 are available from:  
Test Engineering, Inc.  
12718 Cimarron Path  
San Antonio, TX 78249-3423
- A2.3 *Air Filtration*  
Mack air filter element (p/n 57MD33) and Mack air filter housing (p/n 2MD3183) are available from Mack Trucks, Inc.
- A2.4 *Intercooler*  
When ordering the Modine cooler from Mack Trucks Inc., instruct the dealers to use P/N 5424 03 928 031. Because it is a non-stocked part in the Mack Parts Distribution System, it will appear as an invalid P/N. Explain that the P/N is valid and that you want to have it expedited on a *Ship Direct* purchase order. It will then be shipped from Modine to you, bypassing the normal parts Distribution System.
- A2.5 Solvent for cleaning parts (Section 7.4.1) is available from local petroleum product suppliers.
- A2.6 PC-9 Reference Diesel Fuel is available from:  
  
Chevron Phillips  
Phillips 66 Co. Marketing Services Center  
P.O. Box 968  
Borger, TX 79008-0968
- A2.7 Oil cooler adapter blocks are available from:  
Southwest Research Institute  
6220 Culebra Road  
P.O. Drawer 28510  
San Antonio, TX 78228-0510  
  
Ph: 210-522-5244  
Fax: 210-523-6919
- A2.8 Pencool 3000 is available from The Penray Companies, Inc., 100 Crescent Center Pkwy., Suite 104, Tucker, GA 30084.

A2.9 Keil Probes are available from United Sensor Corp., 3 Northern Blvd., Amherst, NH 03031.

A2.10 Bulldog EO-N Premium Plus Oil (or later) is available from local Mack Truck dealers.

**TABLE A2.1  
NEW PARTS FOR EACH REBUILD**

PART NAME	MACK PART NUMBER	QUANTITY
1. Cylinder liners	509GC471	6
2. Piston Assembly		
Piston Crown	240GC5125M	6
Piston Skirt	240GC5119M	6
3. Piston Rings		
#1 Compression ring	349GC3113	6
#2 Compression ring	349GC3108	6
Oil ring	350GC343	6
4. Overhaul gasket sets	57GC2176	2
	57GC2178A**	1
	57GC2179	1
5. Spin-on filters	485GB3236	2
Centrifugal filter cartridge	236GB244B (57GC2134A Kit)	1
6. Engine coolant conditioner	25MF435B	1
7. Primary fuel filter	483GB470AM	1
8. Secondary fuel filter	483GB471M	1
9. Valve guides	714GB3111	24
10. Valve stem seals	446GC332	24
11. Inlet insert	13GC316	12
12. Exhaust insert	13GC317	12
13. Valve stem key	54GC25	48
14. Inlet valve	690GC410	12
15. Exhaust valve	688GC344	12
16. Connecting rod bearings	62GB2396A	6
17. Main Bearings	57GC387	7
18. Thrust Washers	714GC41	2
	714GC42	2

\*\*The 57GC2178A does not contain the 446GC332 valve stem seal (item 10) that is to be used with the 2002 cylinder heads. Be sure to use only the 446GC332 valve stem seal. The correct new gasket set p/n (with the correct valve stem seal) will replace the 57GC2178A once it is created.

### **A3. DETERMINATION OF OPERATIONAL VALIDITY**

#### *A3.1 Quality Index Calculation*

- A3.1.1 Calculate Quality Index (QI) for all control parameters according to the DACA II Report. Be sure to account for missing or bad quality data according to the DACA II Report as well.
- A3.1.2 Use the U, L, Over Range, and Under Range values shown in Table A3.1 for the QI calculations.
- A3.1.3 Round the calculated QI values to the nearest 0.001.
- A3.1.4 Report the QI values on Form5.

#### *A3.2 Averages*

- A3.2.1 Calculate averages for all control, ranged, and non-control parameters and report the values on Form 5.
- A3.2.2 The averages for control and non-control parameters are not directly used to determine operational validity but they may be helpful when an engineering review is required (refer to section A3.4).

#### *A3.3 Determining Operational Validity*

- A3.3.1 QI threshold values for operational validity are shown in Table A3.1. Specifications for all ranged parameters are shown in Table A3.1.
  - A3.3.1.1 A test with EOT QI values for all control parameters equal to or above the threshold values and with averages for all ranged parameters within specifications is operationally valid, provided that no other operational deviations exist that may cause the test to be declared invalid.
  - A3.3.1.2 A test with any control parameter QI value less than the threshold value requires an engineering review to determine operational validity (Section A3.4).
  - A3.3.1.3 With the exception of crankcase pressure, a test with a ranged parameter average value outside the specification is invalid. A test with crankcase pressure outside the specification requires an engineering review to determine operational validity.

#### *A3.4 Engineering Review*

- A3.4.1 Conduct an engineering review when a control parameter QI value is below the threshold value. A typical engineering review involves investigation of the test data to determine the cause of the below threshold QI. Other affected parameters may also be included in the engineering review. This can be helpful in determining if a real control problem existed and the possible extent to which it may have impacted the test. For example, a test runs with a low QI for fuel flow. An examination of the fuel flow data may show that the fuel flow data contains several over range values. At this point, an examination of exhaust temperatures may help determine whether the instrumentation problem affected real fuel flow versus affecting only the data acquisition.

- A3.4.2 For reference oil tests, the engineering review shall be conducted jointly with the TMC. For non-reference oil tests, optional input is available from the TMC for the engineering review.
- A3.4.3 Determine operational validity based upon the engineering review and summarize the decision in the comment section on Form 11. It may be helpful to include any supporting documentation at the end of the test report. The final decision regarding operational validity rests with the laboratory.

**TABLE A3.1  
QUALITY INDEX AND AVERAGE CALCULATION VALUES**

Control Parameter	Units	Quality Index Threshold	Quality Index U & L Values		Over & Under Range Values	
			U	L	Low	High
Speed	r/min	0.000	1802.5	1797.5	1663	1937
Fuel Flow	kg/h	0.000	54.50	52.50	0.0	108.3
Inlet Manifold Temp.	°C	0.000	70.8	69.2	26.2	113.8
Coolant Out Temp.	°C	0.000	66.9	65.1	35.7	134.3
Fuel In Temp.	°C	0.000	40.6	39.4	12.6	67.4
Oil Gallery Temp.	°C	0.000	88.6	87.4	55.1	120.9
Intake Air Temp.	°C	0.000	26.0	24.0	-29.8	79.8
Ranged Parameter	Units	Range			Over & Under Range Values	
					Low	High
Inlet Air Restriction	kPa	3.5 – 4.0			-9.9	17.4
Inlet Manifold Pressure	kPa	Tbd			Tbd	tbd
Exhaust Back Pressure	kPa	2.7 – 3.5			-18.8	25.0
Crankcase Pressure	kPa	0.25 – 0.75			-13.20	14.20
Intake CO <sub>2</sub>	%	1.5 ± 0.05			0	4.20

**A4. TEMPERATURE TO INJECTION TIMING CORRELATION**

<b>Intake Manifold Temperature</b>	<b>Injection Timing (°BTDC)</b>
30	21
40	18
50	15
60	12
70	9
80	6
90	3

## A5. START-UP AND SHUTDOWN PROCEDURES

A5.1 The start-up sequence is shown in Table A5.1.

A5.2 The shutdown sequence is shown in Table A5.2.

A5.3 Emergency (or hard) shutdowns are considered a laboratory safety procedure and are not specified by this test method.

A5.4 The torque values in Tables A5.1 through A5.2 are nominal values. Run the appropriate fuel rates to achieve the nominal torque values.

**TABLE A5.1 START-UP SEQUENCE**

Step	Time (h:mm:ss)	Speed (r/min)	Torque (N•m)	Comments
Prior to start				Set injection timing to 18° BTDC and full EGR bypass
1	0:00:00	idle	0	Engine idle, waiting for oil pressure
	0:00:10	idle	0	Proceed if oil pressure > 138 kPa
2	0:00:11	idle	245	Engine idle, set torque to 245, hold conditions for 4 min 50 s
3	0:05:00	1200	245	Set speed to 1200, linearly ramp torque to 815 in 4 min
	0:09:00	1200	815	End of torque ramp, hold conditions for 2 min 30 s
4	0:11:30	1800	815	Set speed to 1800, linearly ramp torque to 1085 in 2 min
	0:13:30	1800	1085	End of torque ramp, hold conditions for 2 min 30 s
5	0:16:00	1800	1085	Linearly ramp torque to 1300 in 2 min
	0:18:00	1800	1300	End of torque ramp, hold conditions for 2 min 30 s
	0:20:30	1800	1300	Set injection timing and EGR, proceed to test conditions, set fuel rate

**TABLE A5.2 SHUTDOWN SEQUENCE**

Step	Time (h:mm:ss)	Speed (r/min)	Torque (N•m)	Comments
Prior to start of shutdown sequence				Engine running at test conditions
1	0:00:00	1800	1300	Set EGR to full bypass, linearly ramp torque to 815 in 1 min
	0:01:00	1800	815	End of torque ramp, hold conditions for 1 min
2	0:02:00	1800	815	Linearly ramp torque to 270 in 1 min 30 s
	0:03:30	1800	270	End of torque ramp, hold conditions for 3 min 30 s
3	0:07:00	1800	270	Linearly ramp torque to 0 in 1 min, linearly ramp speed to idle in 2 min
	0:08:00	ramping	0	End of torque ramp
	0:09:00	idle	0	End of speed ramp, hold conditions for 1 min
4	0:10:00	idle	0	Stop engine in 1 s
	0:10:01	0	0	End of shutdown

## A6. SAFETY PRECAUTIONS

### A6.1 *General*

- A6.1.1 The operating of engine tests can expose personnel and facilities to a number of safety hazards. It is recommended that only personnel who are thoroughly trained and experienced in engine testing should undertake the design, installation and operation of engine test stands.
- A6.1.2 Each laboratory conducting engine tests should have their test installation inspected and approved by their Safety Department. Personnel working on the engines should be provided with proper tools, be alert to common sense safety practices, and avoid contact with moving, and hot engine parts, or both. Guards should be installed around all external moving or hot parts. When engines are operating at high speeds, heavy duty guards are required and personnel should be cautioned against working alongside the engine and coupling shaft. Barrier protection should be provided for personnel. All fuel lines, oil lines, and electrical wiring should be properly routed, guarded, and kept in good order. Scraped knuckles, minor burns, and cuts are common if proper safety precautions are not taken. Safety masks or glasses should always be worn by personnel working on the engines and no loose or flowing clothing, including long hair or other accessory to dress which could become entangled, should be worn near running engines.
- A6.1.3 The external parts of the engines and the floor area around the engines should be kept clean and free of oil and fuel spills. In addition, all working areas should be free of tripping hazards. Personnel should be alert for leaking fuel or exhaust gas. Leaking fuel represents a fire hazard and exhaust gas fumes are noxious. Containers of oil or fuel cannot be permitted to accumulate in the testing area.
- A6.1.4 The test installation should be equipped with a fuel shut-off valve which is designed to automatically cutoff the fuel supply to engine when the engine is not running. A remote station for cutting off fuel from the test stand is recommended. Suitable interlocks should be provided so that the engine is automatically shutdown when any of the following events occur: engine or dynamometer water temperature becomes excessive; engine loses oil pressure; dynamometer loses field current; engine overspeeds; exhaust system fails; room ventilation fails; or the fire protection system is activated.
- A6.1.5 Consider an excessive vibration pickup interlock if equipment operates unattended. Fixed fire protection equipment should be provided.
- A6.1.6 Normal precautions should be observed whenever using flammable solvents for cleaning purposes. Make sure adequate fire fighting equipment is immediately accessible.



## A7. FUEL PROPERTIES

**TABLE A7.1**  
**PC-9 Reference Diesel Fuel**

<u>PROPERTY</u>	<u>TEST METHOD</u>	<u>MINIMUM</u> <sup>1</sup>		<u>MAXIMUM</u> <sup>1</sup>
Sulfur, mass %	D 2622	0.04		0.05
Gravity, °API	D 287 or D 4052	34.5		36.5 (37)
Hydrocarbon Composition, % Vol.				
Aromatics	D 1319 (FIA)	(27) 28		33
Olefin	D 1319 (FIA)		Report	
Cetane Number	D 613	(40) 42		48
Cetane Index	D 4737 & D 976		Report	
Copper Strip Corrosion	D 130			1
Flash Point, °C	D 93	54		
Pour Point, °C	D 97			-18
Cloud Point, °C	D 2500		Report	
Carbon Residue on 10% Residuum, mass %	D 524 (10% Bottoms)			0.35
Water & Sediment, Vol. %	D 2709			0.05
Viscosity, cSt @ 40°C	D 445	2.4		3.0
Ash, mass %	D 482			0.005
Total Acid Number	D 664			0.05
Strong Acid Number	D 664			0.00
Accelerated Stability	D 2274		Report	
Distillation, °C	D 86			
IBP			Report	
10% Vol.			Report	
50% Vol.			Report	
90% Vol.		282		338
EP			Report	

**A: Minimum/Maximum numbers in parentheses are EPA Certification Fuel Specifications.**

This standard is subject to revision at any time by the responsible technical committee and shall be reviewed every five years and if not revised, either reapproved or withdrawn. Your comments are invited either for revision of this standard or for additional standards and should be addressed to ASTM Headquarters. Your comments will receive careful consideration at a meeting of the responsible technical committee, which you may attend. If you feel that your comments have not received a fair hearing, you should make your views known to the ASTM Committee on Standards, 100 Barr Harbor Drive, West Conshohocken, PA 19428-2959.

---

<sup>1</sup>This test method is under the jurisdiction of ASTM Committee D02 on Petroleum Products and Lubricants and is the direct responsibility of Subcommittee D02.0B on Automotive Lubricants. Current edition approved MMMM DD, YYYY. Published MMM YYYY

<sup>2</sup>The American Society for Testing and Materials takes no position respecting the validity of any patent rights asserted in connection with any item mentioned in this standard. Users of this standard are expressly advised that determination of the validity of any such patent rights, and the risk of infringement of such rights, are entirely their own responsibility.

<sup>3</sup>The ASTM Test Monitoring Center will update changes in this test method by means of Information Letters. This edition includes all information letters through 02-2. Information letters may be obtained from the ASTM Test Monitoring Center, 6555 Penn Avenue, Pittsburgh, PA 15206-4489, Attention: Administrator.

<sup>4</sup>Annual Book of ASTM Standards, VOL 05.01

<sup>5</sup>Annual Book of ASTM Standards, Vol 06.04

<sup>6</sup>Annual Book of ASTM Standards, VOL 05.02

<sup>7</sup>Annual Book of ASTM Standards, VOL 05.03

<sup>8</sup>Annual Book of ASTM Standards, VOL 05.04

<sup>9</sup>Annual Book of ASTM Standards, VOL 14.02

<sup>10</sup>Annual Book of ASTM Standards, VOL 14.03

<sup>11</sup>Available from Robert Bosch GmbH, Postfach 50, D-7000 Stuttgart 1., Germany.

<sup>12</sup>Subcommittee B Glossary may be obtained from the ASTM Test Monitoring Center, 6555 Penn Avenue, Pittsburgh, PA 15206-4489, Attention: Administrator.

<sup>13</sup>Aeroquip lines are available at local industrial hose suppliers.

<sup>14</sup>Available from Viking Pump, Inc., A Unit of IDEX Corporation, 406 State Street, P.O. Box 8, Cedar Falls, Iowa 50613-0008

<sup>15</sup>The Specification for PC-9 Reference Diesel Test Fuel may be obtained from the ASTM Test Monitoring Center, 6555 Penn Avenue, Pittsburgh, PA 15206-4489, Attention: Administrator.

<sup>16</sup>Mack Service Manuals are available from local Mack Trucks, Inc. distributors.

<sup>17</sup>The Data Acquisition and Control Automation II Task Force Report may be obtained from the ASTM Test Monitoring Center, 6555 Penn Avenue, Pittsburgh, PA 15206-4489, Attention: Administrator.

<sup>18</sup>The Lubricant Test Monitoring System may be obtained from the ASTM Test Monitoring Center, 6555 Penn Avenue, Pittsburgh, PA 15206-4489, Attention: Administrator.