

This document is not an ASTM standard; it is under consideration within an ASTM technical committee but has not received all approvals required to become an ASTM standard. It shall not be reproduced or circulated or quoted, in whole or in part, outside of ASTM committee activities except with the approval of the chairman of the committee having jurisdiction and the president of the society. Copyright ASTM, 100 Barr Harbor Drive, West Conshohocken, PA 19428-2959. All Rights Reserved.

Test Method Manuscript
ASTM Designation: DXXXX – XX

OPEN ITEMS

- 1. The intercooler delta p spec needs to be set.

Standard Test Method for Caterpillar C13 Test¹

1. Scope

1.1 This test method is commonly referred to as the Caterpillar C13 Heavy-Duty Engine Oil Test². The test method defines a heavy-duty diesel engine test procedure conducted under high output conditions to evaluate engine oil performance with regard to piston deposit formation, piston ring sticking and oil consumption control in a combustion environment designed to minimize exhaust emissions.

1.2 The values stated in SI units are to be regarded as the standard. The values given in parenthesis are for information only. The only exception is where there is no direct SI equivalent such as screw threads, national pipe threads/diameters, and tubing sizes.

1.3 This standard does not purport to address all of the safety concerns, if any, associated with its use. It is the responsibility of the user of this standard to establish appropriate safety and health practices, and determine the applicability of regulatory limitations prior to use. See Annex A1 for general safety precautions.

1.4 Table of Contents:

Scope	1
Referenced Documents	2
Terminology	3
Summary of Test Method	4
Significance and Use	5
Apparatus	6
Test Engine Configuration	6.1
Test Engine	6.1.1
Oil Heat Exchanger and Engine Oil System	6.1.2
Oil Pan Modification	6.1.3
Engine Control Module	6.1.4
Crankshaft Position Sensor	6.1.5
Air Compressor	6.1.6
Test Stand Configuration	6.2
Engine Mounting	6.2.1

Intake Air System	6.2.2
Intercooler	6.2.3
Exhaust System	6.2.4
Fuel Supply	6.2.5
Coolant System	6.2.6
Pressurized Oil Fill System	6.2.7
External Oil System	6.2.8
Crankcase Aspiration	6.2.9
Blowby Rate	6.2.10
Wastegate Control	6.2.11
System Time Responses	6.3
Oil Sample Containers	6.4
Mass Balance	6.5
Engine and Cleaning Fluids	7
Test Oil	7.1
Test Fuel	7.2
Engine Coolant	7.3
Solvent	7.4
Preparation of Apparatus	8
Cleaning of Parts	8.1
General	8.1.1
Engine Block	8.1.2
Cylinder Head	8.1.3
Rocker Cover and Oil Pan	8.1.4
External Oil System	8.1.5
Rod Bearing Cleaning and Measurement	8.1.6
Ring Cleaning and Measurement	8.1.7
Side Clearance Measurement	8.1.8
Engine Assembly	8.2
General	8.2.1
Parts Reuse and Replacement	8.2.2
Build-Up Oil	8.2.3
Coolant Thermostat	8.2.4
Fuel Injectors	8.2.5
Piston Cooling Tubes	8.2.6
New Parts	8.2.7
Operational Measurements	8.3
Units and Formats	8.3.1
Instrumentation Calibration	8.3.2
Temperatures	8.3.3
Pressures	8.3.4
Flow Rates	8.3.5
Humidity	8.3.6
Engine/Stand Calibration and Non-Reference Oil Tests	9
General	9.1
New Test Stand	9.2

New Test Stand Calibration	9.2.1
Stand Calibration Period	9.3
Stand Modification and Calibration Status	9.4
Test Numbering System	9.5
General	9.5.1
Reference Oil Tests	9.5.2
Non-Reference Oil Tests	9.5.3
Reference Oil Test Acceptance	9.6
Unacceptable Reference Oil Test	9.7
Reference Oil Accountability	9.8
Non-Reference Oil Tests	9.9
Last Start Date	9.9.2
Donated Reference Oil Test Programs	9.10
Adjustments to Reference Oil Calibration Periods	9.11
Test Procedure	10
Engine Installation and Stand Connections	10.1
Coolant System Fill	10.2
Oil Fill for Break-in and test	10.3
Engine Build Committed	10.3.3
Fuel Samples	10.4
Engine Warm-up and Break-in	10.5
Shutdown During Break-in	10.5.1
Valve Lash Adjustment	10.5.2
Engine Warm -up	10.6
Shutdown and Maintenance	10.7
Normal Shutdown	10.7.1
Emergency Shutdown	10.7.2
Maintenance	10.7.3
Downtime	10.7.4
500-h Test Procedure	10.8
Zero-hour and 4-hour oil samples	10.8.2
Operating Conditions	10.8.3
Test Timer	10.8.4
Operational Data Acquisition	10.8.5
Oil Purge, Sample and Addition	10.8.6
End of Test (EOT)	10.9
Engine Disassembly	10.9.4
Calculations, Ratings and Test Validity	11
Rod Bearing Mass Loss	11.1
Ring Mass Loss	11.2
Piston Ratings	11.3
Oil Analyses	11.4
Piston Ring Loss of Side Clearance	11.5
Oil Consumption	11.6
Fuel Analyses	11.7
Assessment of Operational Validity	11.8

Test Report	12
Precision and Bias	13
Keywords	14
Annexes	
Safety Precautions	Annex A1
Intake Air Intercooler	Annex A2
Engine Build Parts	Annex A3
Sensor Locations and Special Hardware	Annex A4
External Oil System	Annex A5
Fuel Specification	Annex A6
Caterpillar Service Publications	Annex A7
Specified Units and Formats	Annex A8
Report Forms and Data Dictionary	Annex A9
Ring loss of side clearance worksheets	Annex A10
Piston Rating Locations	Annex A11
Oil Analyses	Annex A12
Determination of Operational Validity	Annex A13
Oil Temperature Control System	Annex A14
Appendixes	
Non-Mandatory Suppliers List	X1
Typical System Configurations	X2

2. Referenced Documents (TBD)

2.1 ASTM Standards:

- D 86 Standard Test Method for Distillation of Petroleum Products⁴
- D 92 Standard Test Method for Flash and Fire Points by Cleveland Open Cup⁴
- D 97 Standard Test Method for Pour Point of Petroleum Products⁴
- D 129 Standard Test Method for Sulfur in Petroleum Products⁴
- D 130 Standard Test Method for Detection of Copper Corrosion from Petroleum Products by the Copper Strip Tarnish Test⁴
- D 235 Standard Specification for Mineral Spirits²⁰
- D 287 Standard Test Method for API Gravity of Crude Petroleum and Petroleum Products (Hydrometer Method)⁴
- D 445 Standard Test Method for Kinematic Viscosity of Transparent and Opaque Liquids (and the Calculation of Dynamic Viscosity)⁴
- D 482 Standard Test Method for Ash from Petroleum Products⁴
- D 524 Standard Test Method for Ramsbottom Carbon Residue of Petroleum Products⁴
- D 613 Standard Test Method for Cetane Number of Diesel Fuel Oil⁵
- D 664 Standard Test Method for Acid Number of Petroleum Products by Potentiometric Titration⁴
- D 1319 Standard Test Method for Hydrocarbon Types in Liquid Petroleum Products by Fluorescent Indicator Absorption⁴
- D 2500 Standard Test Method for Cloud Point of Petroleum Products⁴
- D 2622 Standard Test Method for Sulfur in Petroleum Products by x-ray Spectrometry⁶
- D 2709 Standard Test Method for Water and Sediment in Middle Distillate Fuels by

Centrifuge⁶

D 2896 Standard Test method for Base Number of Petroleum Products by Potentiometric Perchloric Acid Titration⁶

D 4485 Specification for Performance of Engine Oils⁶

D 4737 Standard Test Method for Calculated Cetane Index by Four Variable Equation⁷

D 4739 Standard Test method for Base Number Determination by Potentiometric Titration⁷

D 5185 Standard Test Method for Determination of Additive Elements, Wear Metals, and Contaminants in Used Lubricating Oils and Determination of Selected Elements in Base Oils by Inductively Coupled Plasma Atomic Emission Spectrometry (ICP-AES)⁷

D 5302 Test Method for Evaluation of Automotive Engine Oils for Inhibition of Deposit Formation and Wear in a Spark-Ignition Internal Combustion Engine Fueled with Gasoline and Operated Under Low-Temperature, Light Duty Conditions⁷

D 5844 Standard Test Method for Evaluation of Automotive Engine Oils for Inhibition of Rusting (Sequence IID)⁷

D 5967 Standard Test Method for Evaluation of Diesel Engine Oils in T-8 Diesel Engine⁷

D 6483 Standard Test Method for Evaluation of Diesel Engine Oils in T-9 Diesel Engine⁵

D 6618 Standard Test Method for Evaluation of Engine Oils in Diesel Four-Stroke Cycle Supercharged 1M-PC Single Cylinder Test Engine⁵

E 29 Practice for Using Significant Digits in Test Data to Determine Conformance with Specifications⁸

E 178 Standard Practice for Dealing with Outlying Observations

E 344 Terminology Relating to Thermometry in Hydrometry⁹

2.2 Coordinating Research Council:

CRC Manual No. 20¹⁰

2.3 National Archives and Records Administration:

Code of Federal Regulations Title 40 Part 86.310-79¹¹

3. Terminology

3.1 Definitions:

3.1.1 blind reference oil, n — a reference oil, the identity of which is unknown by the test facility. **D 5844**

3.1.2 blowby, n — in internal combustion engines, the combustion products and unburned air-and-fuel mixture that enter the crankcase. **D 5302**

3.1.3 calibrate, v — to determine the indication or output of a measuring device with respect to that of a standard. **E 344**

3.1.4 heavy-duty, adj — in internal combustion engine operation, characterized by average speeds, power output, and internal temperatures that are close to the potential maximum. **D 4485**

3.1.5 heavy-duty engine, adj — in internal combustion engines, one that is designed to allow operation continuously at or close to its peak output. **D 4485**

3.1.6 non-reference oil, n — any oil other than a reference oil, such as a research formulation, commercial oil or candidate oil. **D 5844**

3.1.7 non-standard test, n — a test that is not conducted in conformance with the requirements in the standard test method; such as running in a non-calibrated test stand or using different test equipment, applying different equipment assembly procedures, or using modified operating

conditions.

D 5844

3.1.8 reference oil, n – an oil of known performance characteristics, used as a basis for comparison.

D 4485

3.1.9 test oil, n— any oil subjected to evaluation in an established procedure.

D 6557

3.1.10 wear, n— the loss of material from, or relocation of material on, a surface.

3.1.10.1 Discussion– Wear generally occurs between two surfaces moving relative to each other, and is the result of mechanical or chemical action or by a combination of mechanical and chemical actions.

D 5302

3.2 Definitions of Terms Specific to This Standard:

3.2.1 overhead, n – in internal combustion engines, the components of the valve train located in or above the cylinder head.

3.2.2 valve train, n – in internal combustion engines, the series of components, such as valves, crossheads, rocker arms, push rods and camshaft, that open and close the intake and exhaust valves.

4. Summary of Test Method

4.1 This test method uses a Caterpillar production C13 diesel engine. (See Annex A3 for ordering information). Test operation includes a 60-min. warm-up and break-in, followed by a 4-h cool down and a valve lash adjustment. Following the valve lash adjustment and any other needed adjustments, a 500 h test is begun. The engine is operated under steady-state, rated power conditions known to generate excessive piston deposits and/or oil consumption in field service. Oil consumption is reported as measured in 50 h increments.

4.2 Prior to each test, the engine is cleaned and assembled with new cylinder liners, pistons, piston rings, bearings and certain valve train components. All aspects of the assembly are specified.

4.3 An oil sample is removed and an oil addition, equivalent to the total oil consumed plus the sample, is made at the end of each 50-h period.

4.4 The test stand is equipped with the appropriate instrumentation to control engine speed, fuel flow, and other operating parameters.

4.5 Oil performance is determined by assessing operation for any functional failures due to ring sticking or excessive piston deposits as manifested by a significant increase in oil consumption rate or blowby rate above that established as an average of the 100 h and 150 h data points. Significant loss of side clearance for the second ring is also considered indicative of potential field problems. A detailed evaluation of piston deposits at end-of-test can provide an incremental performance assessment for the test oil.

5. Significance and Use

5.1 This test method was developed to assess the performance of an engine oil with respect to control of piston deposits and maintenance of oil consumption control under heavy-duty operating conditions selected to accelerate deposit formation in a turbocharged, intercooled four-stroke-cycle diesel engine equipped with a combustion system designed to minimize federally controlled exhaust gas emissions.

5.2 This test method may be used for engine oil specification acceptance when all details of this test method are in compliance. Applicable engine oil service categories are promulgated by the American Petroleum Institute and may or may not be included in ASTM Specification D 4485.

5.3 The design of the engine used in this test method is representative of many, but not all,

modern diesel engines. This factor, along with the accelerated operating conditions needs to be considered when extrapolating test results.

6. Apparatus

6.1 Test Engine Configuration: The engine configuration is that of a production 2004 Caterpillar 430 bhp C13 engine, designed for heavy duty on-highway truck use. Critical parts that can affect piston deposit formation are controlled specifically for oil test engine use.

6.1.1 Test Engine — The Caterpillar C13 engine is an electronically controlled, turbocharged, aftercooled, direct injected, six cylinder Diesel engine with an in-block camshaft and a four-valve per cylinder arrangement. The engine uses Caterpillar's ACERT technology featuring multiple injections per cycle and inlet valve actuation control. It features a 2004 US EPA emissions configuration with electronic control of fuel metering, fuel injection timing and inlet valve actuation timing. Information needed to obtain the test engine and required parts may be found in Annex A3.

6.1.2 Oil Heat Exchanger and Engine Oil System — The standard Caterpillar oil heat exchanger core shall be removed and replaced with a stainless core, CAT p/n 1Y-4026. Additionally, a remotely mounted heat exchanger is installed. Control the oil temperature with a dedicated cooling loop and control system which is separate from the engine coolant. The details of the system are shown in Annex A14. Be sure that the oil cooler bypass valve shall be blocked closed.

6.1.3 Oil Pan Modification — Modify the oil pan as shown in Fig. A4.1.

6.1.4 Engine Control Module (ECM) — The ECM defines the desired engine fuel timing and quantity and limits maximum engine speed and engine power. Caterpillar electronic governors are designed to maintain a speed indicated by the throttle position signal. Speed error drives fuel demand (rack). Rack and engine speed are input to the injection duration and timing maps to determine duration and timing commands for the fuel injectors. Use the ECM provided with the engine. Obtain special Oil Test Engine Control software (personality module P/N 250-6675-03) for correct control maps, contact Caterpillar Oil Test Engine Representative (current contact information is available through the TMC) for installation of this software. The Caterpillar Engine Technician (circle R) (ET) service software package, version 2004B SP1, is used to monitor engine parameters, flash software, and change power and injector trim values. The Full Dealer Version is required and must be purchased from a Caterpillar dealer with a yearly subscription.

6.1.5 Crankshaft Position Sensor – The crankshaft position is sensed using a primary sensor at the crankshaft gear and a secondary sensor at the camshaft gear. The secondary sensor provides position information during cranking and in the event of a primary sensor failure. Calibration of the engine control software is required prior to the start of timed test operation.

6.1.6 Air Compressor— The engine-mounted air compressor is not used for this test method. Remove the air compressor and install a block-off plate kit in its place (P/N 227-2574, cover group¹⁴ and P/N 223-3873, plug group¹⁴) (Fig. A4.2).

Note: The Turbo-charger Wastegate must be modified for manual control by replacing the supplied pressure control with a manual linkage. See Figures A4.18 – A4.20.

6.2 Test Stand Configuration:

6.2.1 Engine Mounting — Install the engine so that it is upright and the crankshaft is horizontal.

6.2.1.1 The engine mounting hardware should be configured to minimize block

distortion when the engine is fastened to the mounts. Excessive block distortion may influence test results.

6.2.2 Intake Air System– With the exception of the air filter and the intake air tube, the intake air system is not specified. A typical configuration is shown in Fig. X1.1. Use a suitable air filter. Install the intake air tube (Fig A4.3) at the intake of the turbocharger compressor.

Note 1: Difficulty in achieving or maintaining intake manifold pressure or intake manifold temperature, or both, may be indicative of insufficient or excessive restriction.

6.2.3 Charge Air Cooler – In addition to the Caterpillar supplied charge air cooler, which is engine mounted, a Modine (P/N 1A012865) cooler can be used to simulate the air-to-air charge air cooler used in most field applications. Instructions for obtaining this cooler are shown in A2.1. Alternatively, other charge air coolers can be used with the following limitations: it must provide sufficient cooling capacity to control inlet manifold temperatures in the range specified elsewhere in this test method, pressure drop across **the cooler must not exceed _____ kPa** and it must be equipped with a drain system to continuously remove internal condensate.

6.2.4 Exhaust System – Install the exhaust tube (Fig A4.4) at the discharge flange of the turbocharger turbine housing. The piping downstream of the exhaust tube is not specified. A method to control exhaust pressure is required.

6.2.5 Fuel System – The fuel supply and filtration system is not specified. A typical configuration is shown in Fig. X1.2. The fuel consumption rate is determined by measuring the rate of fuel flowing into the day tank. A method to control the fuel temperature is required.

6.2.6 Coolant System – The system configuration is not specified. A typical configuration consists of a non-ferrous core heat exchanger, a reservoir (expansion tank) and a temperature control valve as shown in Fig. X1.3. Pressurize the system by regulating air pressure at the top of the expansion tank. The system should have a sight glass to detect air entrapment.

6.2.6.1 — Although the system volume is not specified, an excessively large volume may increase the time required for the engine fluid temperatures to attain specification.

6.2.7 Pressurized Oil Fill System – The oil fill system is not specified. A typical configuration includes an electric pump, a 50-L reservoir, and a transfer hose. The pressurized fill is located as shown in Fig A4.21.

6.2.8 External Oil System — Configure the external oil system according to Fig. A5.1. Use a 10 – 13 L volume for the oil reservoir. (Fig. A4.6) Be sure that the oil return is drawn from the bottom of the oil reservoir. Use Viking Pump Model No. SG053514. Nominal pump motor speed is 1725 r/min.

6.2.8.1 Oil Sample Valve Location —Locate the oil sample valve on the return line from the external oil system to the engine. Locate the valve as close to the return pump as possible (Fig. A5.1 & Fig. A4.6)

6.2.8.2 Unacceptable Oil System Materials — Brass or copper fittings can influence used oil wear metals analyses and shall not be used in the external oil system.

6.2.9 Crankcase Aspiration – Vent the blowby gas at the blowby filter housing located at the left front side of the cylinder head cover, as shown in Fig. A4.7. Use crankcase breather p/n 9Y-4357. Use breather spacer p/n 221-3934 or equivalent 20 mm thick plate with a fully open center. Use a p/n 9Y-1758 gasket on each side of the spacer.

6.2.10 Blowby Rate — The general configuration of this system is shown in Annex Figure A4.7. The blowby canister shall be 26.5 L minimum internal volume. The pipe connecting the breather outlet to the blowby canister shall be 3.175 cm, inside diameter, and

inclined downward to the canister. The hose connecting the blowby canister to the flow rate device is not specified but should match closely the inlet of the flow rate device. The flow rate measurement device is not specified; however the TEC Associates, Inc. Model No. YF563C has been shown to give satisfactory results under the conditions specified in this test method.

6.3 System Time Responses – The maximum allowable system time responses are shown in Table 1. Determine system time responses in accordance with the Data Acquisition and Control Automation II (DACA II) Task Force Report¹⁵.

Table 1 Maximum Allowable System Time Responses

Measurement	Time Response (s)
Speed	2.0
Temperature	3.0
Pressure	3.0
Flow	To be determined

6.4 Oil Sample Containers — High-density polyethylene containers are recommended for oil samples. **Warning** — Glass containers may break and may cause injury or exposure to hazardous materials, or both.

6.5 Mass Balance — A balance is required to measure the mass of the rod bearings and piston rings. An electronic or mechanical balance may be utilized. The balance shall have a minimum display resolution of 0.1 mg.

7. Engine and Cleaning Fluids

7.1 Test Oil — Approximately 150 L of test oil is required to complete the test.

7.2 Test Fuel — Approximately 45,000 L of Chevron Philips PC-10 Ultra Low Sulfur Diesel fuel¹⁶ is required to complete the test. Fuel property tolerances are shown in Annex A6.

7.3 Engine Coolant – Use a mixture of 50% mineral-free water and 50% Caterpillar brand coolant, P/N 136-3707 for engine coolant. Mineral-free water is defined as water having a mineral content no higher than 34.4 ppm total dissolved solids. As an option, pre-mixed coolant, P/N 101-2845 may be used directly. The coolant mixture may be reused for 6 test starts or up to 3400 h. Keep the mixture at a 50-50 ratio as determined by using either Caterpillar testers 5P3514 or 5P0957 or an equivalent tester. Keep the coolant mixture free of contamination. Total solids shall remain below 5000 ppm. Keep the additive level correct using Caterpillar test kit P/N 8T5296.

Table 7.3.1 Cat® ELC™ Coolant Concentrate and Premix 50/50 Options

Container Size	1 Gal	5 Gal	55 Gal	275gTote
Concentrate P/N	119-5150	(-)	136-3707	(-)
Premixed 50/50 P/N	101-2844	129-2151	101-2845	222-1534

7.4 Solvent – Use a solvent which meets D 235, Type II, Class C requirements for Aromatic Content (0-2% vol), Flash Point (142°F/61°C, min) and Color (not darker than +25 on Saybolt Scale or 25 on Pt-Co Scale). Obtain a Certificate of Analysis for each batch of solvent from the supplier. (**Warning**—Combustible. Health Hazard. Use adequate safety precautions with all solvents and cleaners.)

8. Preparation of Apparatus

8.1 Cleaning of Parts:

8.1.1 General – The preparation of test engine components specific to the Caterpillar C13 test are indicated in this section. Use the Caterpillar service publications¹⁴ (Annex A7) for the preparation of other engine components. Take precautions to prevent rusting of iron components. In general, the use of an engine parts washer is permitted provided that it is followed by a solvent wash.

8.1.2 Engine Block – Disassemble the engine, including removal of the crankshaft, camshaft, piston cooling tubes, oil pump, and oil gallery plugs. Thoroughly clean the surfaces and oil passages (galleries). Use a brush to clean the oil passages. Removal of camshaft bearings is at the discretion of the laboratory.

8.1.3 Cylinder Head, Intake System and Duct – Disassemble and clean before each test. Scrub using a nylon brush and solvent. It is permissible to wash using an engine parts washer. Finish the cleaning with a solvent wash.

8.1.4 Rocker Cover and Oil Pan – Clean the rocker cover and oil pan. Use a brush as necessary to remove deposits.

8.1.5 External Oil System — Flush the internal surfaces of the oil lines and the external reservoir with solvent. Repeat until the solvent drains clean. Flush solvent through the oil pumps until the solvent drains clean, then air dry.

8.1.6 Rod Bearing Cleaning and Measurement

8.1.6.1 Clean the rod bearings with solvent. Use a non-metallic soft bristle brush if necessary. Avoid handling the rod bearings with bare hands. Use gloves or plastic covered tongs.

8.1.6.2 Spray the rod bearings with air until dry.

8.1.6.3 Rinse the rod bearings in pentane and dry with air.

8.1.6.4 Measure the mass of each bearing half to a tenth of a milligram (xxx.x mg).

8.1.7 Ring Cleaning and Measurement

8.1.7.1 Use the procedure stated in the Mack Test Ring Cleaning and Measuring Procedure (available from the TMC) for ring cleaning. Avoid handling the rings with bare hands. Use gloves or plastic covered tongs.

8.1.8 Ring Side Clearance Measurement Measure the ring side clearances and ring end gaps using the special tools described in A.10, as appropriate. CRC Manual 20 provides a general description of the process. For the top rings, measure the side clearances using four feeler gages of equal width and 0.01 mm graduations at 90 degree intervals around the piston. For the intermediate rings, measure the side clearances for 360 degrees around the piston. Record the minimum side clearance and the location relative to the front of the engine. The thinnest feeler gage used shall be 0.03 mm. Failure to pass the 0.03 mm feeler gage shall be recorded as zero side clearance.

8.1.9 High Pressure Turbocharger – Carefully remove turbine housing from the turbocharger and clean the wastegate valve with solvent and a soft wire brush.

8.2 Engine Assembly:

8.2.1 General — Except as noted in this section, use the procedures indicated in the Caterpillar Service Manual Form SENR9700¹⁴ (Annex A7). Assemble the engine with the components from the Engine Build Parts List (Annex A3).

8.2.2 Parts Reuse and Replacement — Engine components can be reused (except as noted in 8.2.7) provided these meet production tolerances as described in the Caterpillar Service Manual.

8.2.3 Build-Up Oil – Use Mobil EF-411¹³ or test oil to lubricate parts for the engine build. If test oil is used, then the engine build is valid only for the respective test oil.

8.2.4 Coolant Thermostat — Lock the engine coolant thermostat open.

8.2.5 Fuel Injectors – Use p/n 239-4908 fuel injectors. The fuel injectors may be reused, but extreme caution must be exercised to avoid mechanical damage or contamination of the nozzels. Dedicate the injectors to a particular cylinder. Install the injectors according to the method described in the Caterpillar Service Manual Form SENR9700(Annex A7).

8.2.6 Piston Cooling Tubes – targeting of the piston cooling tubes is recommended. Details are available from the TMC.

8.2.7 New Parts – The parts listed below are included in the Engine Build Parts List and are not reusable (except as noted in 10.3.3). Clean the parts prior to use. Replacement of any part listed below during a test will invalidate the test.

8.2.7.1 pistons

8.2.7.2 piston rings (top, second, oil)

8.2.7.3 cylinder liners

8.2.7.4 valves (intake, exhaust)

8.2.7.5 valve stem guides

8.2.7.6 valve inserts

8.2.7.7 connecting rod, main and thrust bearings

8.3 Operational Measurements:

8.3.1 Units and Formats – See Annex A8.

8.3.2 Instrumentation Calibration

8.3.2.1 Fuel Consumption Rate Measurement Calibration — Calibrate the fuel consumption rate measurement system before each reference oil test. Temperature-compensate volumetric systems, and calibrate them against a mass flow device. The flowmeter located on the test stand shall indicate within 0.2% of the calibration standard. Trace the calibration standard to national standards.

8.3.2.2 Temperature Measurement Calibration — Calibrate the temperature measurement systems at least once every six months. Each temperature measurement system shall indicate within ± 0.5 °C of the laboratory calibration standard. Trace the calibration standard to national standards.

8.3.2.3 Pressure Measurement Calibration — Calibrate the pressure measurement systems at least once every six months. Trace the calibration standard to national standards.

8.3.3 Temperatures: Note 2: Table A4.1 lists required and optional temperature, pressure and flow measurement locations.

8.3.3.1 Measurement Location – The temperature measurement locations are specified in this section. The measurement equipment is not specified. Install the sensors such that the tip is located midstream of the flow unless otherwise indicated. The accuracy and resolution of the temperature measurement sensors and the complete measurement system shall follow the guidelines detailed in ASTM Research Report RR: D02-1218¹⁷.

8.3.3.2 Coolant Out Temperature — Install the sensor in the fitting on the thermostat housing (Fig. A4.9).

8.3.3.3 Coolant In Temperature – Install the sensor on the right side of the coolant pump intake housing at the 1-in. NPT port (Fig A4.10).

8.3.3.4 Fuel In Temperature — Install the sensor in the fuel pump inlet fitting (Fig. A4.12).

8.3.3.5 Oil Gallery Temperature — Install the sensor at the 1/4-in. NPT female boss on the right rear of the engine (Fig. A4.11).

8.3.3.6 Intake Air Temperature – Install the sensor in the inlet tube with 12 inches of straight pipe section immediately upstream and rotated 90° from the pressure sensor.(Fig. A4.3)

8.3.3.7 Intake Manifold Temperature — Install the sensor at the 1/8-in. NPT female boss on the outside radius of the inlet manifold elbow (Fig. A4.13)

8.3.3.8 Exhaust Temperature – Install the sensor in the exhaust tube (Fig. A4.4).

8.3.3.9 Additional – Monitor any additional temperatures considered to be beneficial to operational analysis.

Note 3: Additional exhaust sensor locations are recommended, such as the exhaust ports and pre-turbine (front and rear). The detection of changes in exhaust temperature(s) is an important diagnostic.

8.3.4 Pressures:

8.3.4.1 Measurement Location and Equipment – The pressure measurement locations are specified in this section. The measurement equipment is not specified. The accuracy and resolution of the pressure measurement sensors and the complete measurement system shall follow the guidelines detailed in ASTM Research Report RR: D02-1218¹⁷.

8.3.4.2 It may be necessary to install a condensation trap at the lowest elevation of the tubing between the pressure measurement location and the final pressure sensor for Crankcase Pressure, Intake Air Pressure, and Exhaust Pressure. Route the tubing to avoid intermediate loops or low spots before and after the condensation trap.

8.3.4.3 Oil Gallery Pressure — Measure the pressure at the 1/4 in. NPT fitting on the right rear of the engine (Fig. A4.11).

8.3.4.4 Oil Filter Inlet Pressure — Measure the pressure at the plug located on the inlet side of the oil filter assembly (Fig. A4.5).

8.3.4.5 Intake Manifold Pressure — Measure the pressure at the 1/4-in. NPT port on the outside radius of the inlet manifold elbow (Fig. A4.13).

8.3.4.6 Crankcase Pressure — Measure the pressure by installing a bulkhead fitting in the valve cover, top-front (Fig. A4.8).

8.3.4.7 Intake Air Pressure — Measure the pressure at a wall tap on the intake air tube with 12 inches of straight pipe section immediately upstream and rotated 90° from the temperature sensor (Fig. A4.3).

8.3.4.8 Exhaust Pressure — Measure the pressure on the exhaust tube (Fig. A4.4).

8.3.4.9 Fuel Pressure — Measure the pressure at the fuel filter head (Fig. A4.22).

8.3.4.10 Coolant Pressure – Measure the pressure on top of the expansion tank (Fig. X1.3).

8.3.4.11 Intercooler Delta Pressure – Measure the pressure drop across the intercooler. The intercooler inlet pressure is measured at the elbow outlet of the CAT charge air cooler (Fig. A4.16). Use the intake manifold pressure (Section 8.3.4.5) as the intercooler outlet pressure. The intercooler delta pressure is the difference between these two values.

8.3.4.12 Additional Pressures – Monitor any additional pressures considered to be

beneficial.

Note: Additional instrument placement information can be found in Figures A4.16 & A4.17.

8.3.5 Flow Rates:

8.3.5.1 Flow Rate Location and Measurement Equipment — The flow rate measurement locations are specified in this section. The equipment for the blowby rate and the fuel rate are not specified. The accuracy and resolution of the flow rate measurement system shall follow the guidelines detailed in ASTM Research Report RR: DO2-1218¹⁷.

8.3.5.2 Blowby — The device used to measure the blowby flow rate is not specified. See 6.2.10 for blowby measurement system configuration details.

8.3.5.3 Fuel Flow — The fuel consumption rate is determined by measuring the fuel flowing to the day tank (Fig. X1.2).

8.3.6 Humidity – Measure intake air humidity anywhere in the intake air system between air conditioning and the turbo inlet.

9. Engine/Stand Calibration and Non-Reference Oil Tests

9.1 General – Calibrate the test stand by conducting a test with a blind reference oil¹⁵. Submit the results to the ASTM Test Monitoring Center (TMC) for determination of acceptance according to the Lubricant Test Monitoring System (LTMS)¹⁵.

9.2 New Test Stand — A new test stand is defined as a test stand that has never been calibrated or has not completed an acceptable reference oil test within 24 months of the end of test (EOT) date of the last acceptable reference oil test. Perform the following to introduce a new test stand.

9.2.1 New Test Stand Calibration – New stand calibration is determined according to the LTMS¹⁶.

9.3 Stand Calibration Period – The calibration period is 12 500-h non-reference oil tests or 12 months, whichever comes first, from the EOT date of the last acceptable reference oil test.

9.4 Stand Modification and Calibration Status — Stand calibration status may be invalidated by conducting any non-standard test or modification of the test and control systems or both. A non-standard test includes any test conducted under a modified procedure, non-procedural hardware, controller set-point modifications, or any combination thereof. The TMC should be contacted prior to any changes to determine the effect on the calibration status.

9.5 Test Numbering System:

9.5.1 General — The test number has two parts, X-Y. X represents the test stand number, Y represents the sequential test stand run number. For example, test number 27-15 indicates stand number 27, test stand run number 15. Increment Y by one for each test start (reference oil and non-reference oil). A letter suffix may be necessary as well, as stated in 9.5.2.

9.5.2 Reference Oil Tests – A reference oil test conducted subsequent to an unacceptable reference oil test shall include a letter suffix after Z. The letter suffix shall begin with A and increment alphabetically until an acceptable reference oil test is completed. For example, if two consecutive unacceptable reference oil tests were conducted and the first test number was 27-15, the second test number would be 27-16A. A third calibration attempt would have the test number 27-17B. If the third test was acceptable, then 27-17B would identify the reference oil test in the test report.

9.5.3 Non-Reference Oil Tests — No letter suffix shall be added to Z for aborted or operationally invalid non-reference oil tests.

9.6 Reference Oil Test Acceptance:

9.6.1 Reference oil test acceptance is determined in accordance with the LTMS¹⁵.

9.7 Unacceptable Reference Oil Test:

9.7.1 It is recognized that some reference oil test results will not be within the LTMS acceptance limits. The laboratory, in conjunction with the TMC, shall attempt to determine the cause of the deviation. The TMC may solicit input from industry authorities to help determine the cause and extent of the problem.

9.7.2 If the laboratory is not within the LTMS acceptance limits and the TMC has determined that probable cause is isolated to an individual stand, then non-reference oil testing on other calibrated stands may continue.

9.7.3 If the laboratory is not within the LTMS acceptance limits and the TMC has determined that probable cause involves more than one stand, then the TMC may declare the particular stands non-calibrated. Non-reference oil tests in progress at the time of the calibration status change are not affected.

9.7.4 The laboratory shall attempt to identify and correct the cause and conduct an acceptable reference oil test in at least one of the stands to demonstrate resolution of the problem.

9.7.5 The TMC will assign reference oil when satisfied that no particular problems exist or the problem has been resolved. The laboratory shall provide adequate documentation of findings to support the conclusions reached during this process. The conclusions shall be documented in the acceptable reference oil test report.

9.8 Reference Oil Accountability:

9.8.1 Laboratories shall provide a full accounting of the identification and quantities of all reference oils used. With the exception of the oil analyses required in section 11.4, no physical or chemical analyses of reference oils shall be performed without written permission from the TMC. In such an event, include the written confirmation and the data generated in the reference oil test report.

9.8.2 Retain used reference oil samples for 90 days from the EOT date.

9.9 Non-Reference Oil Tests:

9.9.1 This test method incorporates the use of a Severity Adjustment (SA) for non-reference oil test results. A control chart technique described in the LTMS is used to determine if a significant bias exists for delta oil consumption, second ring LSC, and piston deposit rating. When calibration results indicate a significant bias, an SA is determined according to the LTMS and applied to the non-reference oil test result. The SA will remain in effect until a new SA is determined from subsequent calibration tests.

9.9.2 Last Start Date — A non-reference oil test shall commence engine warm-up (10.5) prior to the expiration of the calibration period (9.3).

9.10 Donated Reference Oil Test Programs - The surveillance panel is charged with maintaining effective reference oil test severity and precision monitoring. During times of new parts introductions, new or re-blended reference oil additions, and procedural revisions, it may be necessary to evaluate the possible effects on severity and precision levels. The surveillance panel may choose to conduct a program of donated reference oil tests in those laboratories participating in the monitoring system, in order to quantify the effect of a particular change on severity and precision. Typically, the surveillance panel requests its panel members to volunteer enough reference oil test results to create a robust data set. Broad laboratory participation is needed to provide a representative sampling of the industry. To ensure the quality of the data obtained, donated tests are conducted on calibrated test stands. The surveillance panel shall arrange an

appropriate number of donated tests and ensure completion of the test program in a timely manner.

9.11 Adjustments to Reference Oil Calibration Periods

9.11.1 Procedural Deviations – On occasions when a laboratory becomes aware of a significant deviation from the test method, such as might arise during an in-house review or a TMC inspection, the laboratory and the TMC shall agree on an appropriate course of action to remedy the deviation. This action may include the shortening of existing reference oil calibration periods.

9.11.2 Parts and Fuel Shortages - Under special circumstances, such as industry-wide parts or fuel shortages, the surveillance panel may direct the TMC to extend the time intervals between reference oil tests. These extensions shall not exceed one regular calibration period.

9.11.3 Reference Oil Test Data Flow - To ensure continuous severity and precision monitoring, calibration tests are conducted periodically throughout the year. There may be occasions when laboratories conduct a large portion of calibration tests in a short period of time. This could result in an unacceptably large time frame when very few calibration tests are conducted. The TMC can shorten or extend calibration periods as needed to provide a consistent flow of reference oil test data. Adjustments to calibration periods are made such that laboratories incur no net loss (or gain) in calibration status.

9.11.4 Special Use of the Reference Oil Calibration System - The surveillance panel has the option to use the reference oil system to evaluate changes that have potential impact on test severity and precision. This option is only taken when a program of donated tests is not feasible. The surveillance panel and the TMC shall develop a detailed plan for the test program. This plan requires all reference oil tests in the program to be completed as close to the same time as possible, so that no laboratory/stand calibration is left in an excessively long pending status. In order to maintain the integrity of the reference oil monitoring system, each reference oil test is conducted so as to be interpretable for stand calibration. To facilitate the required test scheduling, the surveillance panel may direct the TMC to lengthen and shorten reference oil calibration periods within laboratories such that the laboratories incur no net loss (or gain) in calibration status.

10. Test Procedure

10.1 Engine Installation and Stand Connections — Install the test engine on the stand and connect the engine to the stand support equipment.

10.2 Coolant System Fill — Fill the cooling system with pre-diluted Caterpillar Extended Life Coolant (see 7.3 for part numbers and available container sizes). The coolant for non-reference oil tests may be reused provided the level of inhibitors is within specification. Use new coolant for each reference oil test.

Note 6: The coolant system should be pressurized to specification and checked for leaks prior to adding the test oil.

10.3 Oil Fill for Break-in and test:

10.3.1 Install a new Caterpillar 1R-0716 oil filter¹⁴.

10.3.2 Use the pressurized oil fill system (6.2.8) to charge the engine with 32.8 ± 0.2 kg of test oil at the location shown in Fig. A4.5.

10.3.3 Engine Build Committed – After the test oil has been introduced into the engine, the engine build and the test number are valid only for the respective test. However, if the engine has not been cranked (whereby the test parts have not been subjected to wear or injected fuel, or both),

then the new parts may be used again. Disassemble and clean the engine according to 8.1.

10.4 Fuel Samples – Take a 1.0 L fuel sample at the start of the test and at EOT.

10.5 Engine Warm-up and Break-in — Prior to firing the engine, ensure that the oil temperature is at least 15 °C. The minimum oil gallery startup pressure is 350 kPa. Perform a timing calibration for the engine control software and timing sensor components as specified in the C13 Service Manual. If coolant temperature is less than 18C the engine will operate under cold mode strategy and the timing calibration procedure cannot be performed. In this situation, start the engine and allow it to idle until the speed drops from 1000 r/m to 600 r/m, signaling that the coolant temperature has exceeded 18C. After the timing calibration is complete, stop the engine and remove the timing measurement equipment. Immediately restart the engine and begin the warm-up and break-in conditions as shown in Table 2. Turn on the external oil weigh system pumps at the beginning of stage 2.

Table 2
Break-in Conditions

Parameter	unit	Stage				
		1	2	3	4	5
Stage Length	min	5	5	10	20	20
Speed	r/min	1100	1200	1600	1800	1800±5
Fuel Flow	g/min	record	record	record	record	1200±6
Torque	N•m	0	480	1000	1160	record
Coolant Out Temperature ^Δ	°C	88	88	88	88	88±2
Oil Gallery Temperature ^Δ	°C	record >>				98±2
Intake Manifold Temperature ^Δ	°C	40	40	40	40	40±2

^Δ This is the control set-point, can require up to 30 minutes of operation to achieve.

10.5.1 Shutdown during Break-in – If a shutdown occurs during the break-in, resume the break-in from the point the shutdown occurred. Note such an occurrence in Other Comments of Fig. A9.11 (Form 11) listed in Table A9.1.

Note 7: Use the break-in as an opportunity to confirm engine performance and to make repairs prior to the start of the 500-h test procedure.

10.5.2 Valve Lash Adjustment – At the completion of the 60-m break-in, shut the engine down, using the normal shut down procedure as shown in 10.7.1. Allow the engine to cool for a minimum of 4 hours and then perform the valve lash adjustment as defined in the Caterpillar Service Manual. Inlet valve actuator lash adjustment should also be made at this time.

10.6 Warm-up -- Start the engine, perform the warm-up (Table 3) and proceed directly to the test conditions. At engine start, the oil gallery temperature is to be at least 15 °C. The startup oil gallery pressure is to be at least 350 kPa.

Table 3
Warm-up Conditions

Parameter	unit	Stage				
		1	2	3	4	5
Stage Length	min	2.5	2.5	5	10	10
Speed	r/min	1100	1200	1600	1800	1800
Fuel Flow	g/min	record	record	record	record	1200
Torque	N•m	0	480	1000	1160	record

Coolant Out Temperature ^Δ	°C	88	88	88	88	88
Oil Gallery Temperature ^Δ	°C	record	record	record	record	98±2
Intake Manifold Temperature ^Δ	°C	40	40	40	40	40

^Δ This is a control set-point, and can require up to 30 minutes of operation to achieve.

10.7 Shutdown and Maintenance – The test may be shut down at the discretion of the laboratory to perform repairs. However, the intent of this test method is to conduct the 500-h test procedure without shutdowns.

10.7.1 Normal Shut Down: A normal shut down is accomplished by ramping in 30 seconds from test conditions to stage 2 of the Warm-up Conditions (Table 3), running for 5 minutes at stage 2, ramping in 30 seconds to stage 1, running for 5 minutes at stage 1 and then stopping the engine.

10.7.2 Emergency Shutdown – An emergency shutdown occurs when the normal shutdown cannot be performed, such as an alarm condition. Note such an occurrence in the Other Comments section of Fig. A9.11 (Form 11) listed in Table A9.1.

10.7.3 Maintenance — Engine components or stand support equipment, or both, may be repaired or replaced at the discretion of the laboratory and in accordance with this test method.

10.7.3.1 Caution deposits tend to build up with time and prevent free movement of the turbo-charger wastegate shaft. If the engine is shut down for maintenance at any time the shaft should be freed mechanically. Otherwise, such a procedure must be followed if the IMP falls outside the 275 to 285 kPa range and does not respond to normal adjustment techniques.

10.7.4 Downtime — The limit for total downtime and number of shutdowns is not specified. Record all shutdowns, pertinent actions, and total downtime during the 500-h test procedure on Fig. A9.11 (Form 11) listed in Table A9.1.

10.8 500-h Test Procedure:

10.8.1 Start test with warm-up and break-in, normal shutdown, valve lash adjustment and warm-up, as described in 10.2 through 10.7.

10.8.2.1 Zero-hour Oil Sample – Take a 120 ml oil sample of the fresh oil from the original oil container. Take an additional 120 ml oil sample after 4 hours of operation at test conditions. Replace the 4-h sample with 120 ml of fresh oil.

10.8.3 Operating Conditions – After warm-up, proceed directly to the 500-h Test Schedule (Table 4).

Table 4
500-h Test Schedule of Conditions

Parameter	unit	
Test Length	h	500
Speed	r/min	1800 ± 5
Power	kW	record
Torque (typical) ^A	N•m	1760
Fuel Flow	g/m	1200±6
Intake Manifold Temp.	°C	40±2
Blowby Flow	L/min	record
Coolant Out Temp.	°C	88 ± 2
Coolant In Temp.	°C	record
Coolant Delta Temp.	°C	record
Fuel In Temp.	°C	40 ± 2

Oil Gallery Temp.	°C	98 ± 2
Turbo Inlet Temp.	°C	record
Intake Manifold Press.	kPa g	275-285
Exhaust Temp.	°C	record
Fuel Pressure	kPa	record
Oil Gallery Pressure	kPa	record
Oil Filter Delta Press.	kPa	record
Coolant System Press. ^B	kPa	99-107
Exhaust restriction	kPa	6 ± 1
Crankcase Press.	kPa	record
Inlet Air Press.	kPa abs.	92 – 98
Intercooler Delta Press	kPa	tbd
Humidity	g/kg	record

^A At standard atmospheric temperature and pressure

^B Measure the coolant pressure on the top of the expansion tank

10.8.4 Test Timer – The 500-h test timer starts when all controlled parameters shown in Table 4 are within specification. If a shutdown occurs, stop the test timer immediately at the initiation of the shutdown. The test timer shall resume when the test has been returned to the test operation schedule and all controlled parameters are within specification.

10.8.5 Operational Data Acquisition — Record all operational parameters shown in Table with automated data acquisition at a minimum frequency of once every 6 min. Recorded values shall have minimum resolution in accordance with Annex A8.

10.8.5.1 The operational data is reported on Form 5 listed in Table A9.1.

10.8.6 Oil Purge, Sample and Addition — Perform a purge and oil sample at 4 h. Do not add fresh oil a 4 h. Perform a purge, oil sample, and oil addition at the end of each 50-h period. Add new oil, and purge sample to the external oil system reservoir.

10.8.6.1 Do not shut down the engine for oil sampling and oil addition.

10.8.6.2 Full Weight — Record the oil weight indicated by the external oil system at the completion of the fourth test hour and before removal of the 150 ml purge and the 120 ml oil sample; this value establishes the full weight

10.8.6.3 At the end of each 50-h period, record the oil weight indicated by the external oil system and take a 150 ml oil purge sample followed by a 120 ml oil analysis sample. Identify the oil sample container with the test number, oil code, date and test hour.

10.8.6.4 Add new oil equivalent to Full Weight minus the external oil system weight (as determined in step 10.8.6.3), plus the 120 ml sample. Add back the purge sample taken in 10.8.6.3. At 500 hours make no oil additions.

10.8.6.5 Emergency Oil Adds If the external oil weigh system retained weight falls to 0.5 kg or less at any time before the next scheduled 50-h oil add point calculate, based on the immediately preceding oil consumption history, calculate the amount of oil required to maintain the external oil weigh system weight above 0.5 kg until the next scheduled add. Add this amount of fresh oil to the system.

10.9 End of Test (EOT):

10.9.1 After completing the test procedure, perform a normal shutdown. Release the coolant system pressure and drain the coolant. Disconnect the test stand support equipment.

Warning — The coolant and oil may be hot. The installation of a valve to safely vent the

coolant system pressure is recommended.

10.9.2 Drain the oil from the engine and the external oil system.

10.9.3 Engine Disassembly – Disassemble the engine and remove the following components for ratings and measurements:

10.9.3.1 Pistons

10.9.3.2 Piston Rings (**Caution:** do not remove rings from pistons until ring sticking has been rated.)

10.9.3.3 Rod Bearings

11. Calculations, Ratings and Test Validity

11.1 Rod Bearing Mass Loss — Use the procedure shown in 8.1.7 to determine individual EOT rod bearing mass.

11.1.1 Calculate the mass loss for each rod bearing section (pre-test - post test).

11.1.2 Calculate the average mass loss and the standard deviation of the mass loss.

11.2 Ring Mass Loss – NOTE: See section 11.3.1 prior to removal of the piston rings for mass loss determination. Use the procedure shown in 8.1.8 to determine individual EOT ring mass.

11.2.1 Calculate the mass loss and gap increase for the top, second, and oil rings (pre-test – post-test).

11.2.2 Calculate the average mass loss, \bar{x} , and the standard deviation of the mass loss, s , for the top, second and oil ring groups.

11.2.3 Calculate the Δ/s for each top ring as follows:

$$\Delta/s = (|x_i - \bar{x}|) / s \quad (\text{Eq. 9})$$

Where:

x_i = individual ring mass loss, mg

\bar{x} = average mass loss of the top ring group

s = standard deviation of the mass loss of the top ring group

11.2.4 A Δ/s value greater than 1.887 is an outlier. Remove the maximum outlier from the top ring group. Remove only one outlier from the top ring group, and recalculate \bar{x} and s . Report the maximum, minimum, average mass loss, and the standard deviation of the mass loss for the top ring group as Outlier Screened in the Other Comments section of Fig. A9.11 (Form 11) listed in Table A9.1.

11.3 Piston Ratings — Rate the pistons according to CRC Manual No. 20¹⁰ at the locations specified using the special instructions noted in Annex A11. Deposit weighting factors are those used for the Caterpillar 1P Test. For the varnish ratings, use the CRC expanded varnish scale and convert to demerits.

11.3.1 Pistons are rated for ring sticking (8.1.8) and loss of side clearance (11.5) prior to removal of the rings for cleaning and weighing.

11.4 Oil Analyses — Analyze the oil samples for viscosity at 100°C, wear metals (iron, copper, lead, chromium, and aluminum), TAN, TBN, **DIR** and mass % soot (TGA) according to the schedule and methods shown in A12.

11.5 Piston Ring Loss of Side Clearance Rate in accordance with CRC Rating Manual #20 and Annex A10. Piston ring side clearance is measured in accordance with 8.1.8 and compared with pre-test measurements to determine loss due to deposits.

11.6 Oil Consumption — Determine the oil consumption rate for each 50-h segment of the test by use of a regression analysis of the external oil system weights recorded over the 50 hour period. Do not include in the regression any values obtained within 4 hours following an oil addition or after the engine is shut down for any reason.

11.7 Fuel Analyses — Report the analyses provided by the fuel supplier on Fig. A9.12 (Form 12) listed in Table A9.1. Report the analyses of the final batch if more than one fuel batch was used.

11.7.1 Additional Analyses — Perform the following analyses on the 1 L new and EOT fuel samples:

11.7.1.1 API Gravity at 15.6 °C (60 °F), Test Method D287 or equivalent

11.7.1.2 Total Sulfur, % wt., Test Method D129 or equivalent

11.8 Assessment of Operational Validity — Determine operational validity according to Annex A13.

12. Test Report

12.1 Report Forms — For reference oil tests the standardized report form set and data dictionary for reporting test results and for summarizing the operational data are required. The report forms and data dictionary are available from the TMC. Instructions for obtaining the report forms and data dictionary and a list of report forms are shown in Annex A9.

12.1.1 Report all wear, deposits, engine operational data, oil analysis, and fuel analysis on the appropriate form in the test report.

12.2 Reference Oil Test — Send the test report forms and any other supporting information, to the TMC¹⁸ by facsimile or electronic transmission within five days of the EOT date for test acceptance determination. Reference oil test reports should be mailed or electronically transmitted to the TMC within 30 days of the EOT date.

12.2.1 Electronic Transmission of Test Results — Use ASTM Data Communications Committee Test Report Transmission Model (Section 2-Flat File Transmission Format)¹⁵

13. Precision and Bias

13.1 Precision — Precision is based on operationally valid calibration test results monitored by the TMC. **The research report (D02 – RR:XXXX) contains industry data developed prior to the establishment of this test method.**

13.1.1 Intermediate Precision Conditions — Conditions where test results are obtained with the same test method using the same test oil, with changing conditions such as operators, measuring equipment, test stands, test engines, and time. **Note** – Intermediate precision is the appropriate term for this test method rather than repeatability which defines more rigorous within-laboratory conditions.

13.1.1.1 Intermediate Precision Limit (i.p.) — The difference between two results obtained under intermediate precision conditions that would in the long run, in the normal and correct conduct of the test method, exceed the values shown in Table 6 in only one case in twenty. When only a single test result is available, the Intermediate Precision Limit can be used to calculate a range (test result ± Intermediate Precision Limit) outside of which a second test result would be expected to fall about one time in twenty.

13.1.2 Reproducibility Conditions — Conditions where test results are obtained with the same test method using the same test oil in different laboratories with different operators using different equipment.

13.1.2.1 Reproducibility Limit (R) — The difference between two results obtained under reproducibility conditions that would, in the long run, in the normal and correct conduct of the test method, exceed the values in Table 6 in only one case in twenty. When only a single test result is available, the Reproducibility Limit can be used to calculate a range (test result \pm Reproducibility Limit) outside of which a second test result would be expected to fall about one time in twenty.

13.1.3 **Test Precision, as of Month DD, YYYY, is shown in Table 6.**

13.2 Bias — Bias is determined by applying a defined statistical technique to calibration test results. When a significant bias is determined, a severity adjustment is applied to the non-reference oil test result.

14. Keywords

14.1 Caterpillar C13, diesel engine oil, lubricants, top ring weight loss, piston ring loss of side clearance, valve train wear bearing wear, oil consumption.

Table 6
Test Precision

Parameter ^A	Intermediate Precision (i.p.)	Reproducibility (R)
	TBD	

^A Precision data are periodically updated and are available from the TMC.

ANNEXES
(Mandatory Information)

- A1. Safety Precautions
- A2. Intake Air Aftercooler
- A3. Engine Build Parts Kit
- A4. Sensor Locations and Special Hardware
- A5. External Oil System
- A6. Fuel Specification
- A7. Caterpillar Service Publications
- A8. Specified Units and Formats
- A9. Report Forms and Data Dictionary
- A10. Piston Ring Loss of Side Clearance and Piston Ring Sticking Worksheets
- A11. Piston Rating Locations
- A12. Oil Analysis
- A13. Determination of Operational Validity

A1. SAFETY PRECAUTIONS

A1.1 The operation of engine tests may expose personnel and facilities to safety hazards. Personnel trained and experienced with engine testing should perform the design, installation, and operation of test stands.

A1.2 Guards (shields) should be installed around all external moving, hot, or cold components. Design the guard to contain the energy level of a rotating component should the component break free. Fuel, oil, coolant and electrical wiring should be properly routed, guarded, grounded and kept in good order.

A1.3 The test stand should be kept free of oil and fuel spills and tripping hazards. Containers of oil or fuel, or both, should not be permitted to accumulate in the testing area. Fire fighting equipment should be immediately accessible. Normal precautions should be observed whenever using flammable solvents for cleaning purposes.

A1.4 Safety masks, glasses, or hearing protection, or a combination thereof, should be worn by personnel working on the test stand. No loose or flowing clothing, including long hair or other accessory to dress, should be worn near rotating equipment. Personnel should be cautioned against working alongside the engine and driveline while the engine is running.

A1.5 Interlocks should automatically shutdown the engine when an anomaly of any of the following occur: engine or dynamometer coolant temperature, engine oil pressure, dynamometer field current, engine speed, exhaust temperature, excessive vibration or when the fire protection system is activated. The interlock should include a method to cut off the fuel supply to the engine at the injector pump (including the return line). A remote fuel cut off station (external to the test stand) is recommended.

A1.6 Employ other safety precautions as required by regulations.

A2. INTAKE AIR AFTERCOOLER

A2.1 Obtain the Modine aftercooler from a Mack Truck dealer. Order the aftercooler using part number 5424 03 928 031. This is a non-stocked part in the Mack Parts Distribution System and will appear as an invalid part number. Instruct the dealer to expedite the aftercooler on a Ship Direct purchase order. The aftercooler will be shipped directly from Modine, bypassing the normal Mack Parts Distribution System.

A3. ENGINE AND ENGINE BUILD PARTS KIT¹²

A3.1 Obtain the Caterpillar C13 Engine Arrangement Number 244-4803 or 249-8361 by contacting the Caterpillar Oil Test Engine Representative. Current contact information is maintained at the ASTM Test Monitoring Center (TMC).

A3.2 Critical parts are shown in Table A3.1.

A3.2.1 Obtain Critical Parts by contacting the Caterpillar Oil Test Engine Representative. Current contact information is maintained at the TMC.

A3.3 A listing of non-critical engine build parts is available from the TMC. This list shows current part numbers so that these may be obtained from a Caterpillar Dealer.

Table A3.1 Engine Build Parts

Item	Part Number
Piston	1Y-4106
Liner-Cylinder	1Y-4107
Ring-Top	1Y-4108
Ring-Intermediate	1Y-4109
Ring-Oil	1Y-4110

A4. SENSOR LOCATIONS AND SPECIAL HARDWARE

A4.1 See Table A4.1 and Figs. A4.1 — A4.19

Table A4.1 Temperature, Pressure and Flow Measurements locations Summary
(Includes optional measurements)

Description	Instrument	Location
Total Coolant In	Temperature	Coolant pump inlet pipe
Engine Coolant In	Temperature	Coolant pump suction
Primary Turbo Compressor Out	Temperature	Cast aluminum pipe between turbos
Inlet Manifold	Temperature	Inlet manifold elbow
Oil Gallery	Temperature	Side of Block
Coolant Out	Temperature	Thermostat Housing
Secondary Turbo Turbine Out	Temperature	Facility Piping - Locate 12 inches after flange/bend and 4 inches before transition
Secondary Turbo Compressor Out	Temperature	Facility Piping
Oil Filter In	Temperature	Oil Filter Housing
Oil Filter Out	Temperature	Oil Filter Housing
Primary Turbo Drain	Temperature	Turbo Drain
Secondary Turbo Drain	Temperature	Turbo Drain
Oil Sump	Temperature	Oil pan plug below oil level
Cyl 1	Temperature	Exhaust Manifold
Cyl 2	Temperature	Exhaust Manifold
Cyl 3	Temperature	Exhaust Manifold
Cyl 4	Temperature	Not accessible
Cyl 5	Temperature	Exhaust Manifold
Cyl 6	Temperature	Exhaust Manifold
Exhaust Manifold Front	Temperature	Exhaust Manifold
Exhaust Manifold Rear	Temperature	Exhaust Manifold
Fuel at Pump	Temperature	Transfer Pump
Oil Regulator	Temperature	Oil Filter Housing
Charge Air Cooler Water In	Temperature	Facility Piping
Total Coolant In	Pressure	Coolant pump inlet pipe
Secondary Turbo Compressor Out	Pressure	Facility Piping
Inlet Manifold	Pressure	Inlet manifold elbow
Oil Gallery	Pressure	Side of Block
Secondary Turbo Turbine Out	Pressure	Facility Piping - Locate 12 inches after flange/bend and 4 inches before transition
Secondary Turbo Compressor Out	Pressure	Facility Piping
Crankcase	Pressure	Valve Cover. Use a bulkhead with seal fitting

Table A4.1 (cont'd)

Fuel at Filter Housing	Pressure	Fuel Filter Housing
Oil Filter In	Pressure	Filter Housing
Oil Filter Out	Pressure	Oil Filter Housing
Exhaust Manifold Front	Pressure	Exhaust Manifold
Exhaust Manifold Rear	Pressure	Exhaust Manifold
Fuel at Pump	Pressure	Transfer Pump
Coolant	Flow	Facility Piping
Fuel	Flow	
Blowby	Flow	

A4.1 Oil Pan Modifications for Auxiliary Oil System

Figure A4.1.1 Auxiliary oil system suction port location

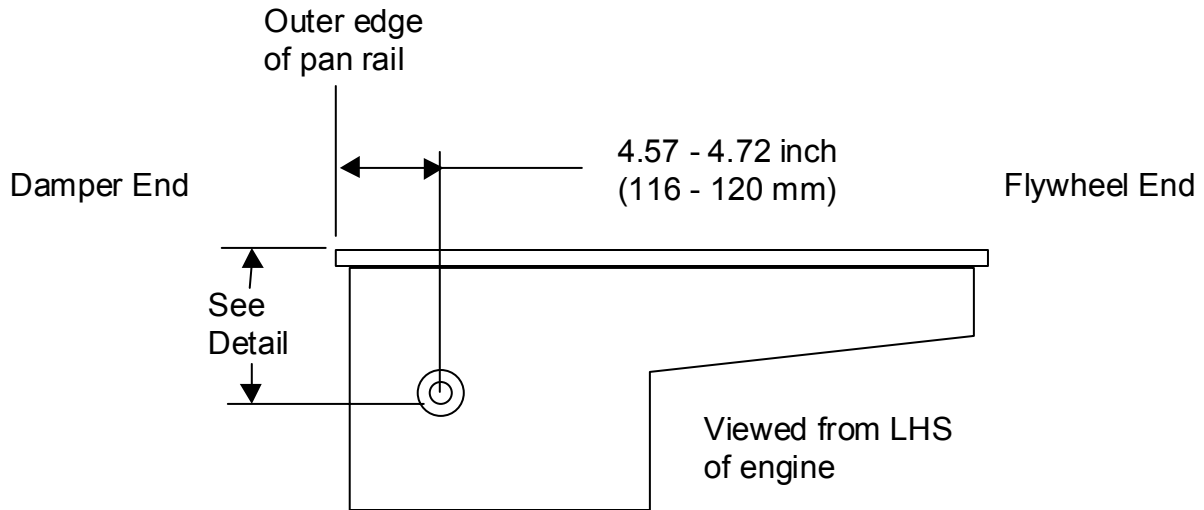

Figure A4.1.2 Auxiliary oil system suction port location

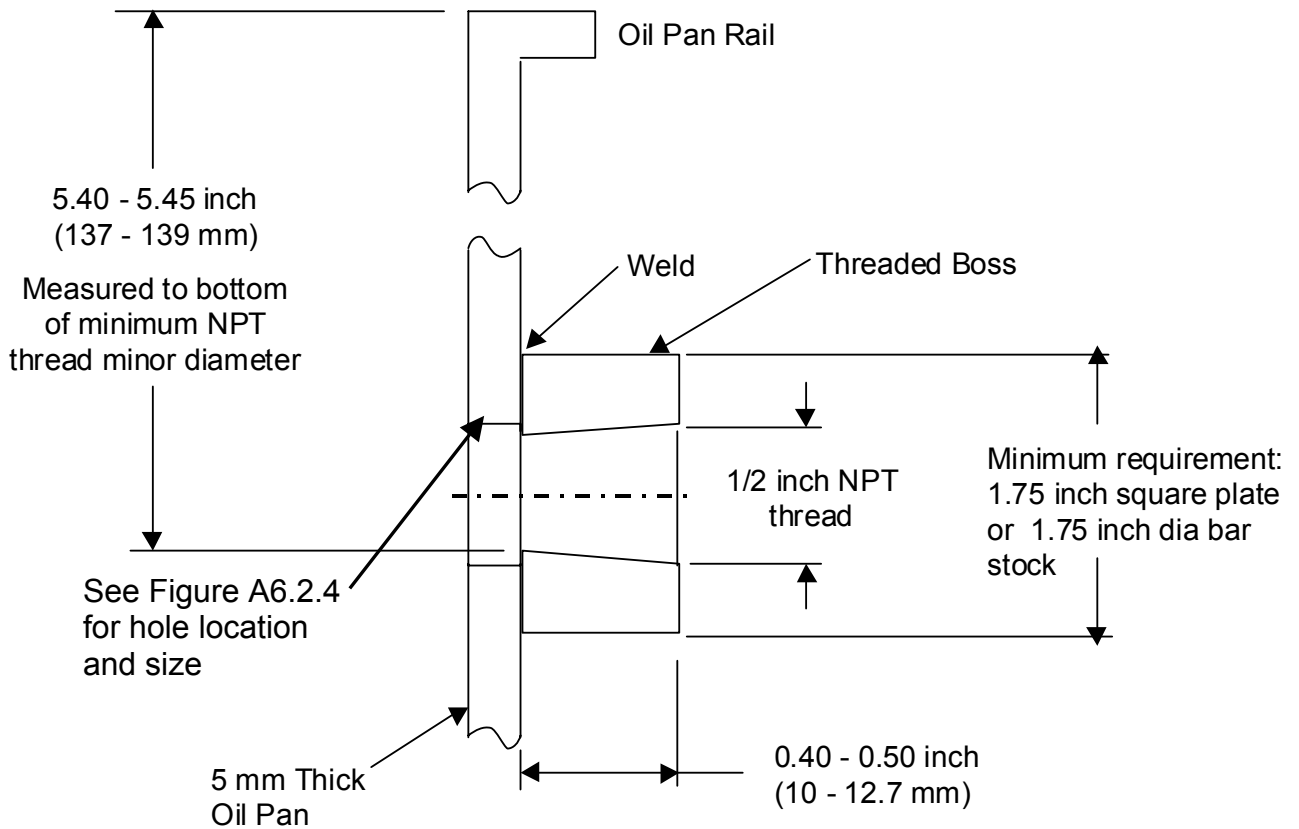
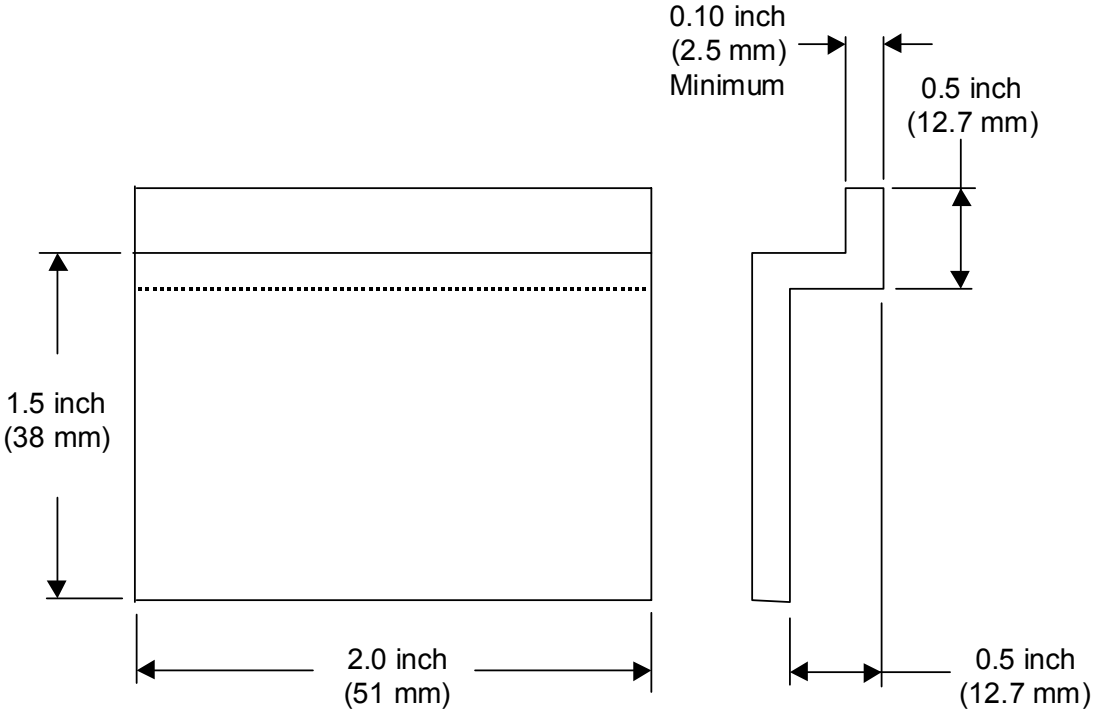

Figure A4.1.3 Suction port baffle design



Note: Bend radii to be compatible with material thickness

Figure A4.1.4 Baffle placement on oil pan

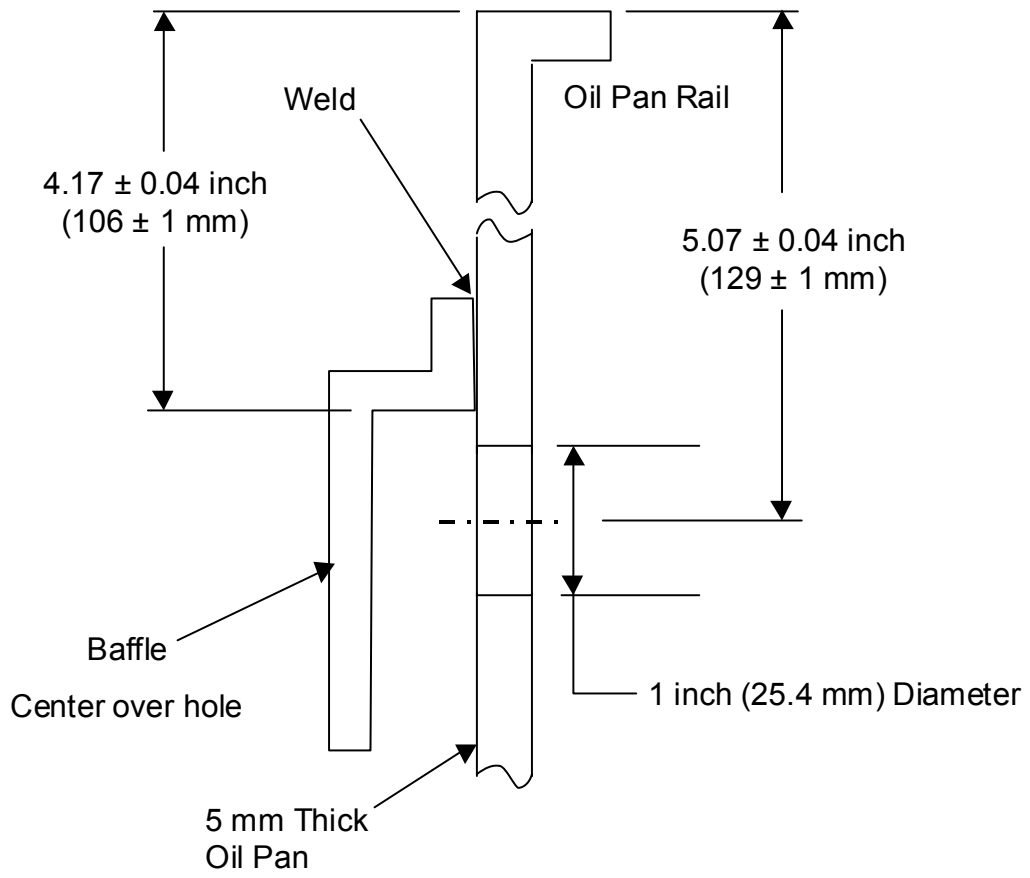
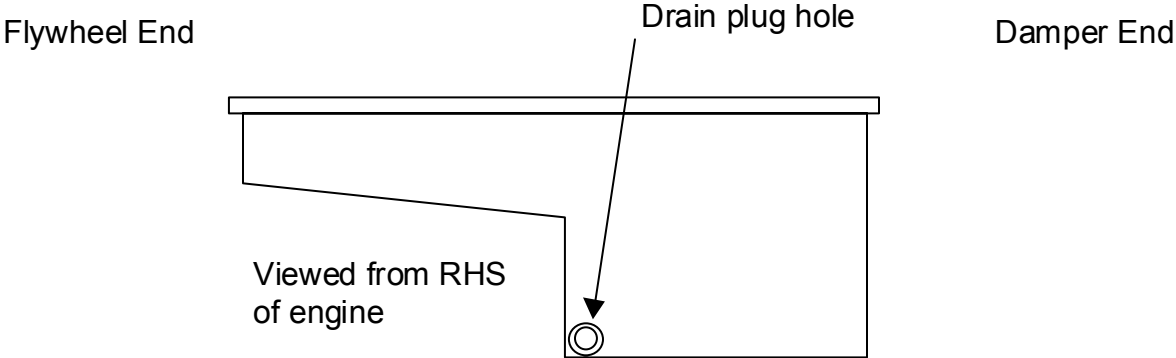

Figure A4.1.5 Auxiliary Oil System Return Port Location



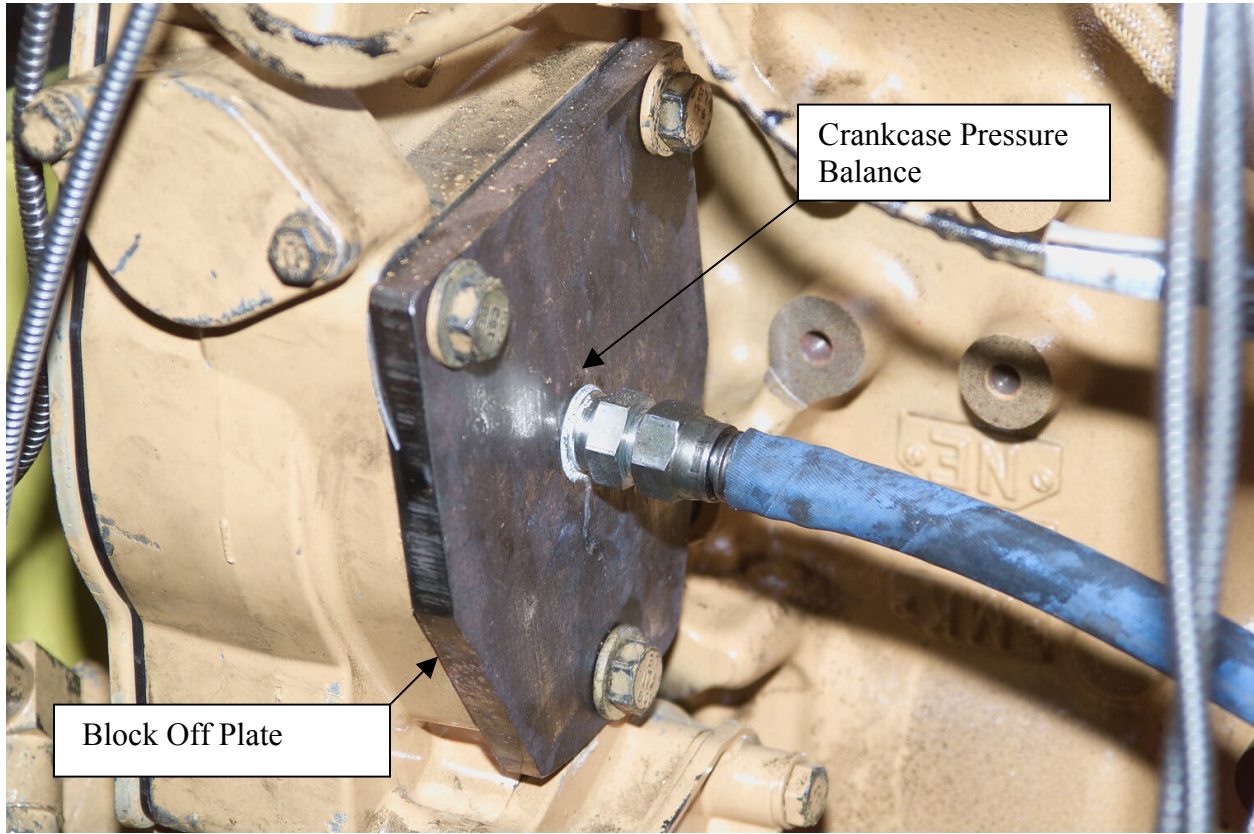

Fig A4.2
Compressor Block off Plate and Crankcase Pressure Balance Connection

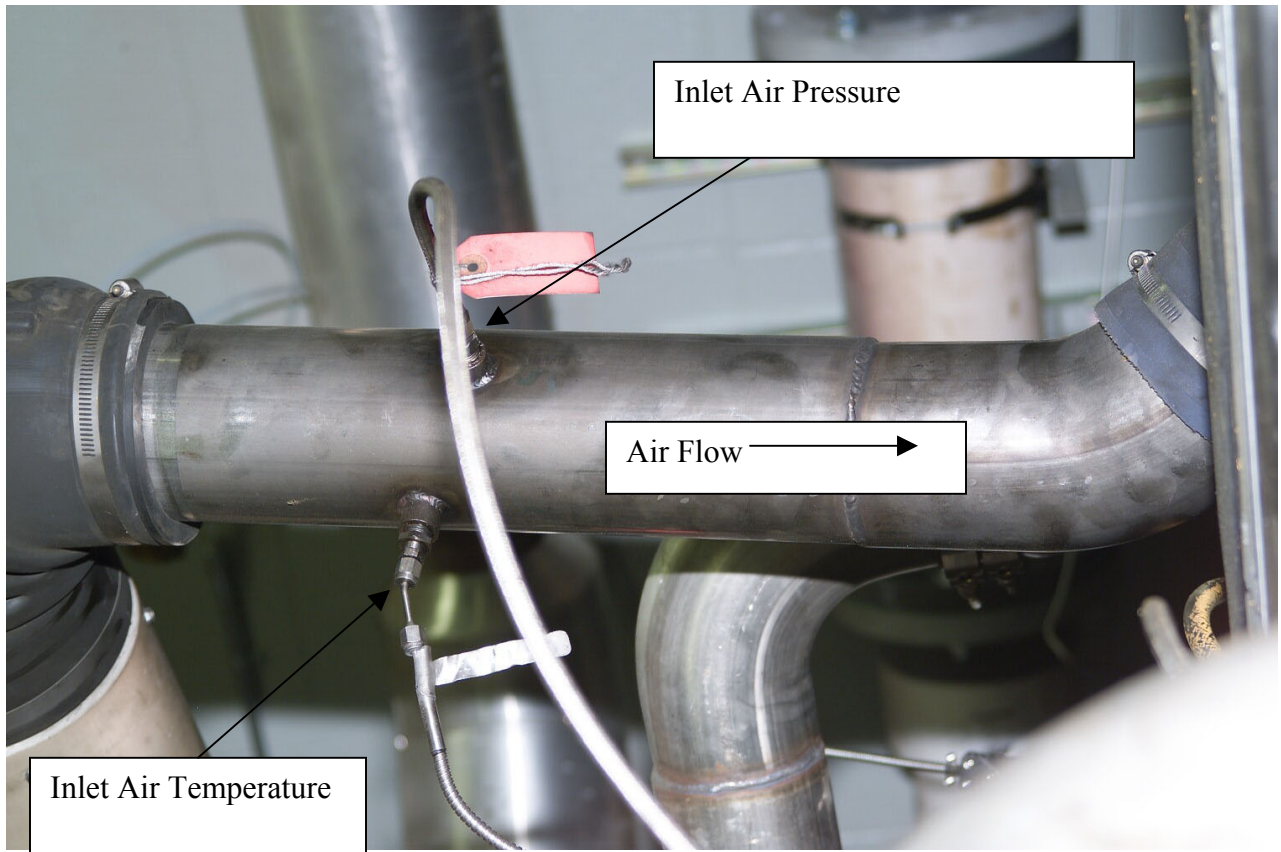

Fig. A4.3 Inlet Tube

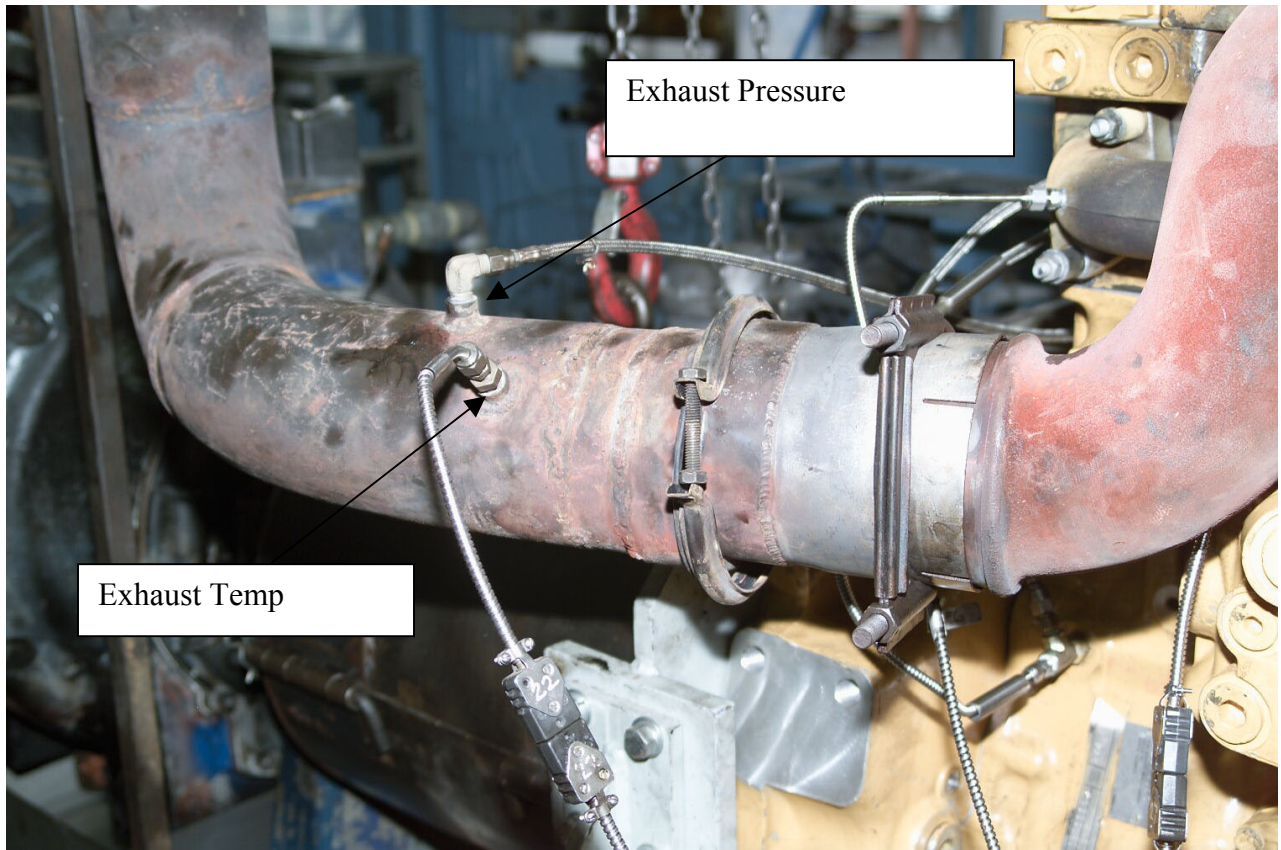

Fig. A4.4 Exhaust Tube

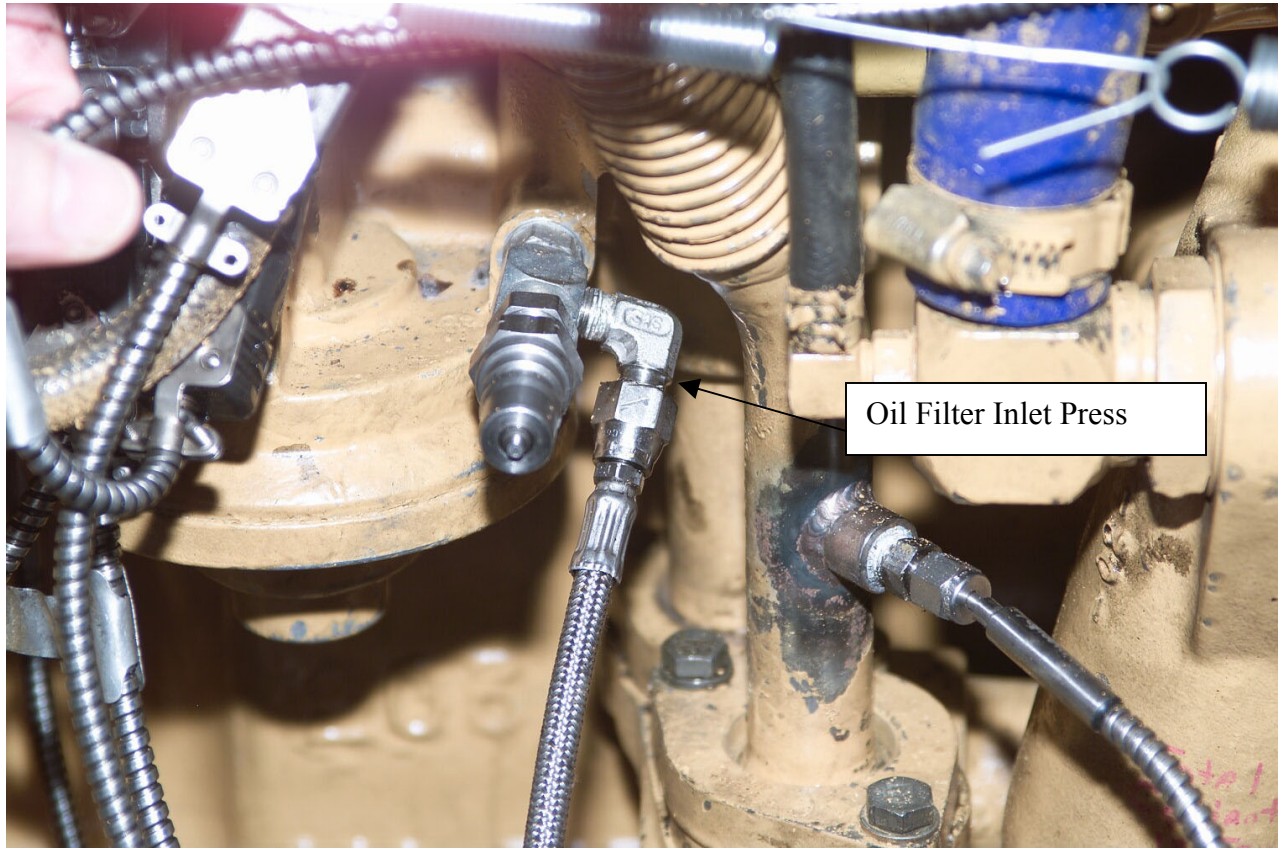

Fig. A4.5 Oil Filter Inlet Pressure Port

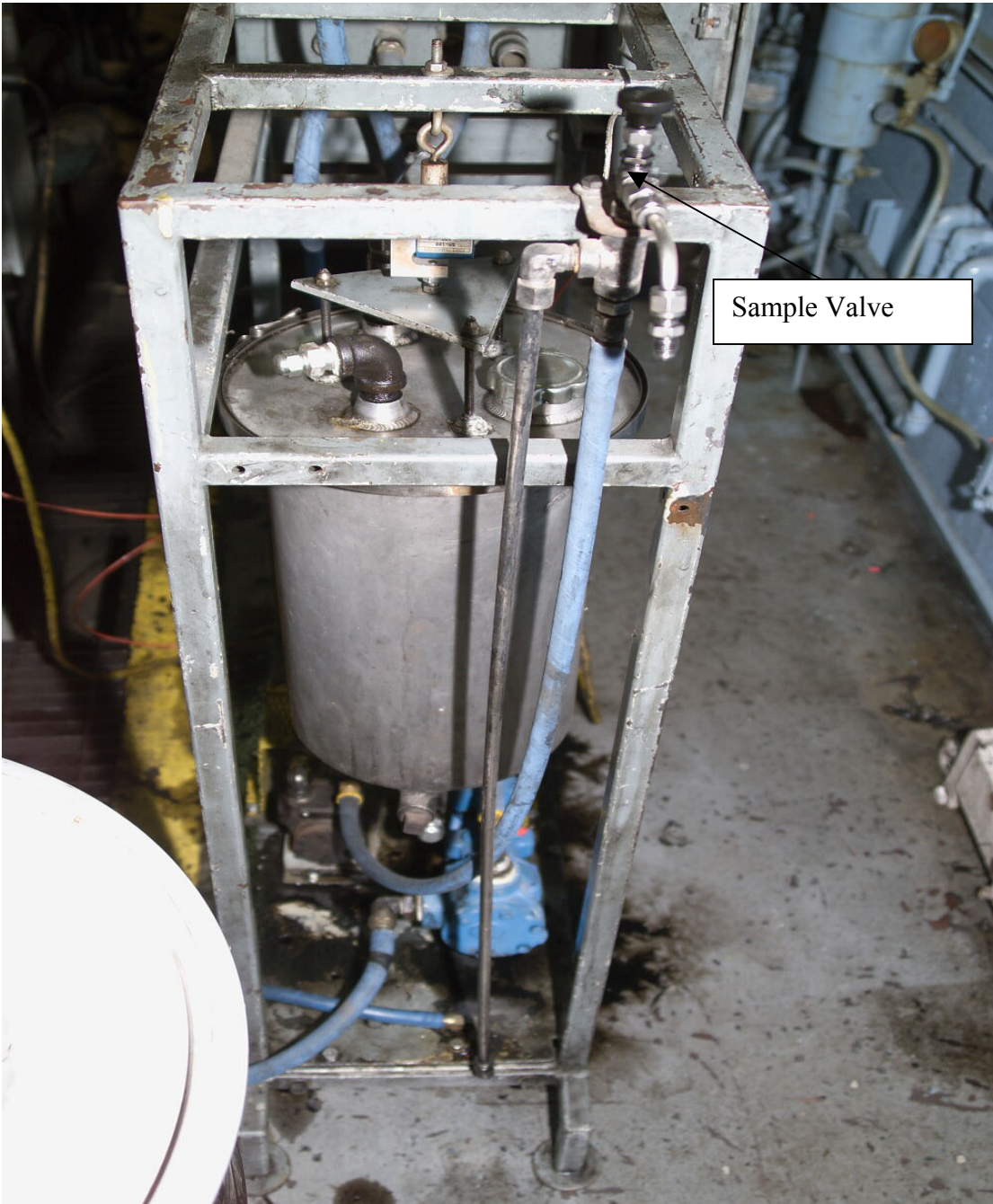
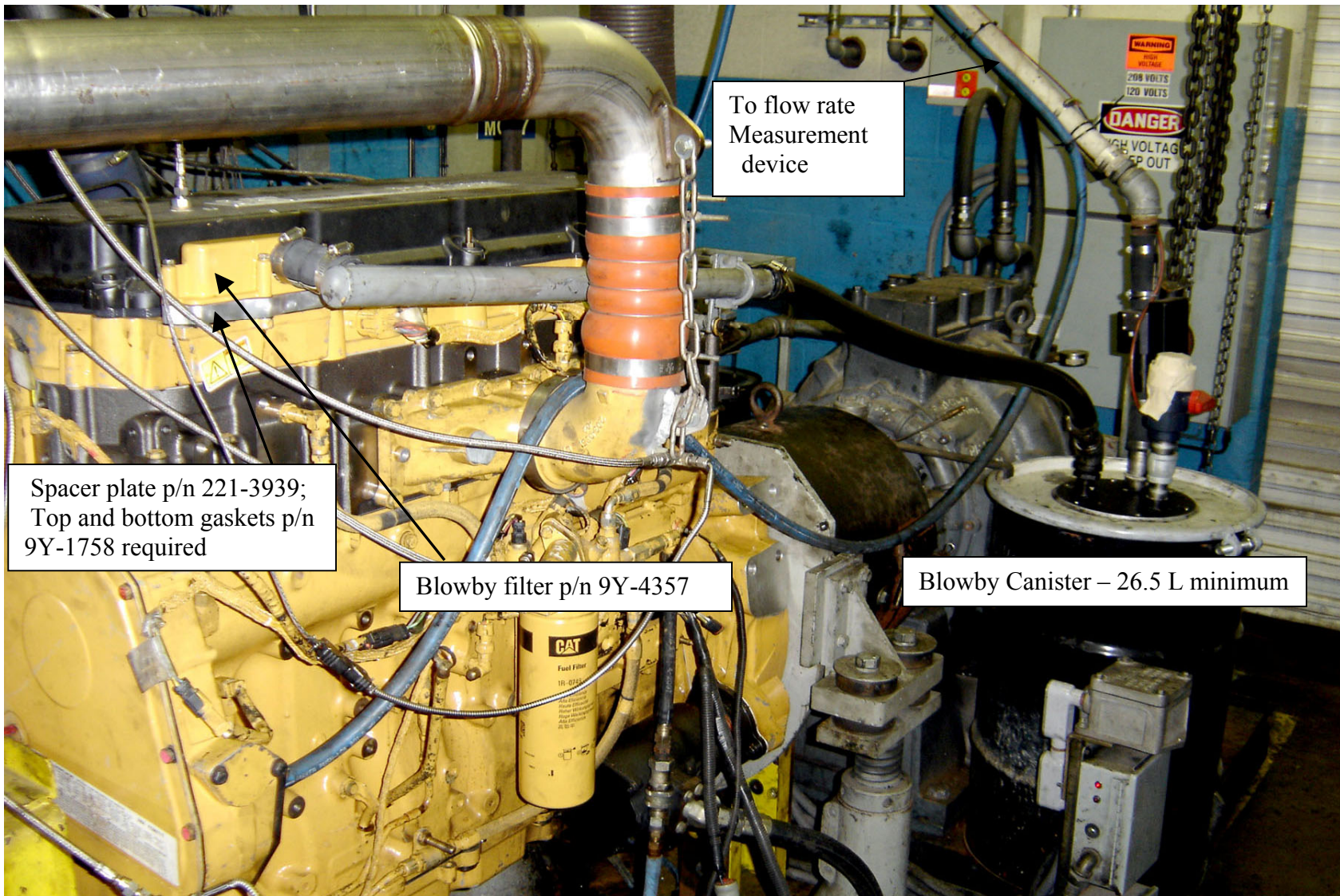

Fig. A4.6 Oil Weight Cart



Spacer plate p/n 221-3939;
Top and bottom gaskets p/n
9Y-1758 required

Blowby filter p/n 9Y-4357

To flow rate
Measurement
device

Blowby Canister – 26.5 L minimum

Figure A4.7 Crankcase Aspiration System

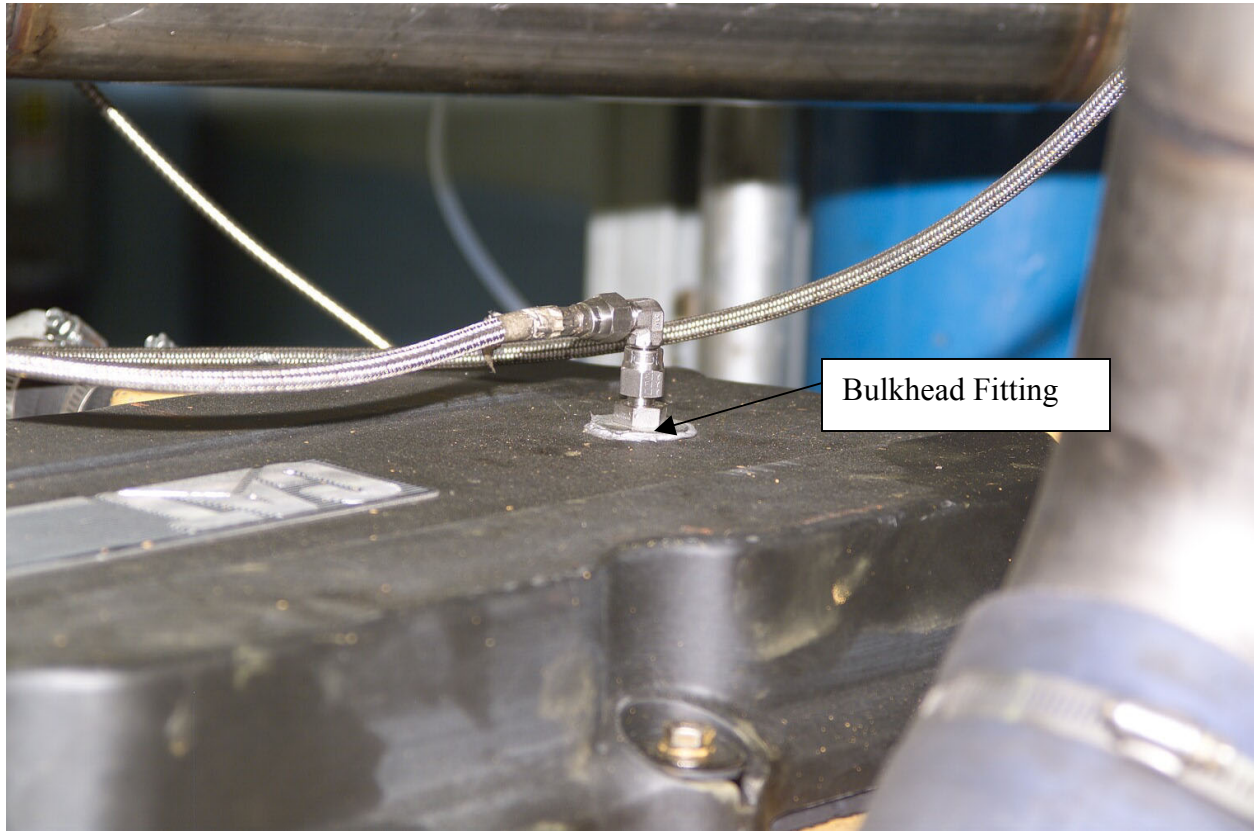

Fig. A4.8 Crankcase Pressure Connection

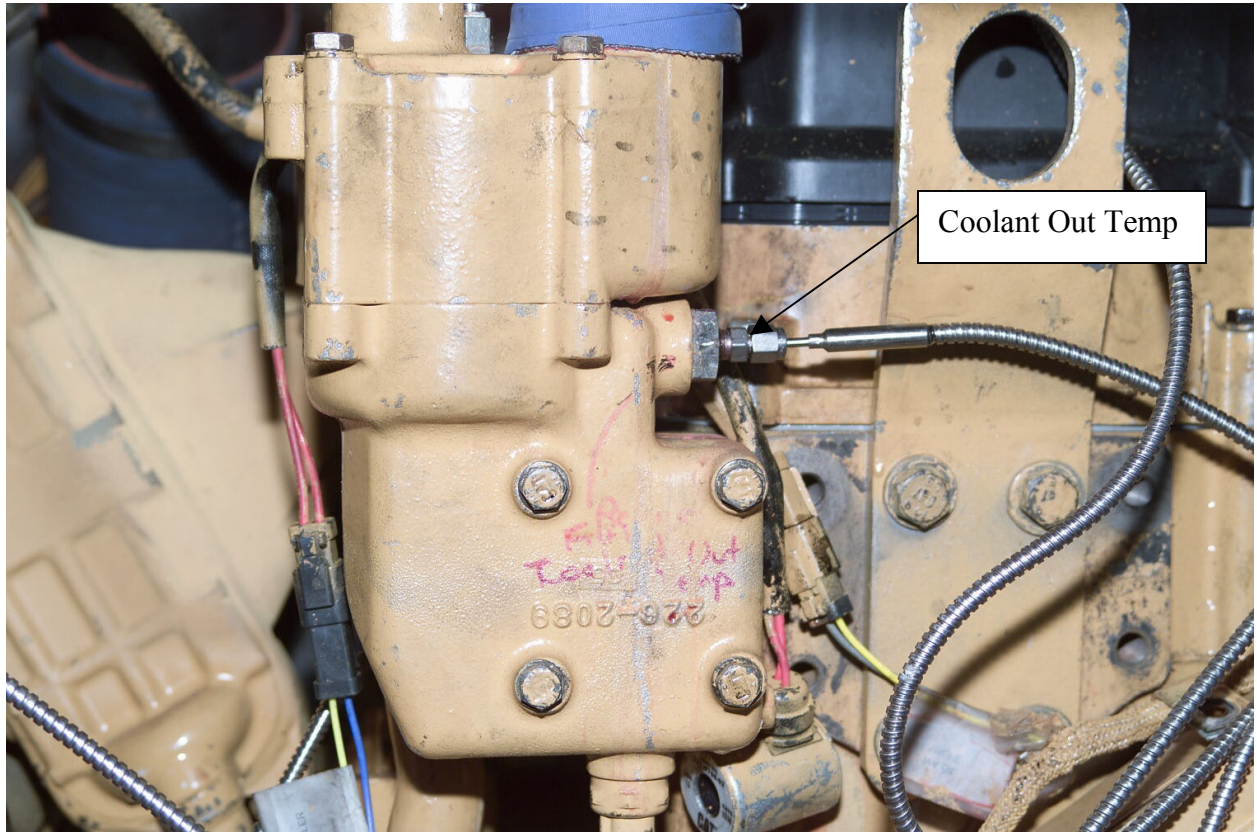

Fig. A4.9 Coolant Outlet Temperature

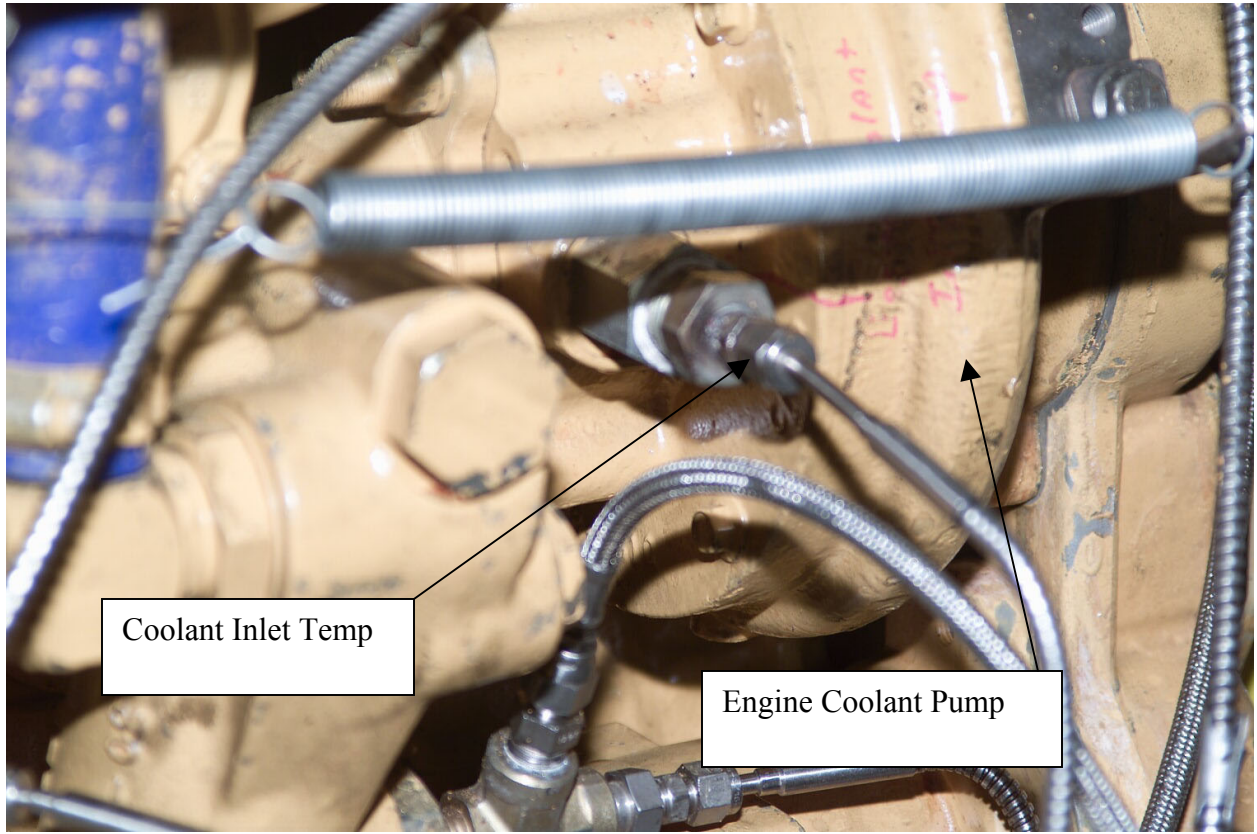

Fig. A4.10 Coolant to Engine

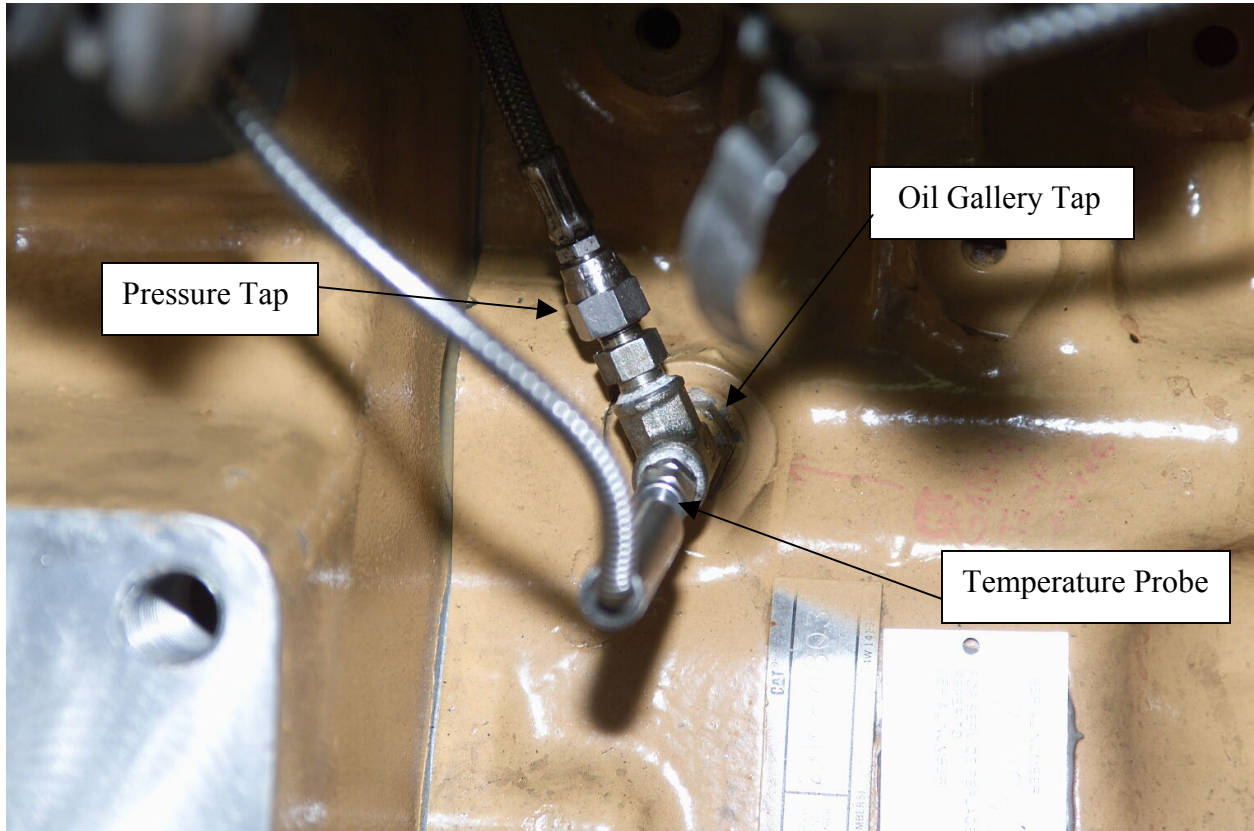

Fig. A4.11 Oil Gallery Pressure and Temperature

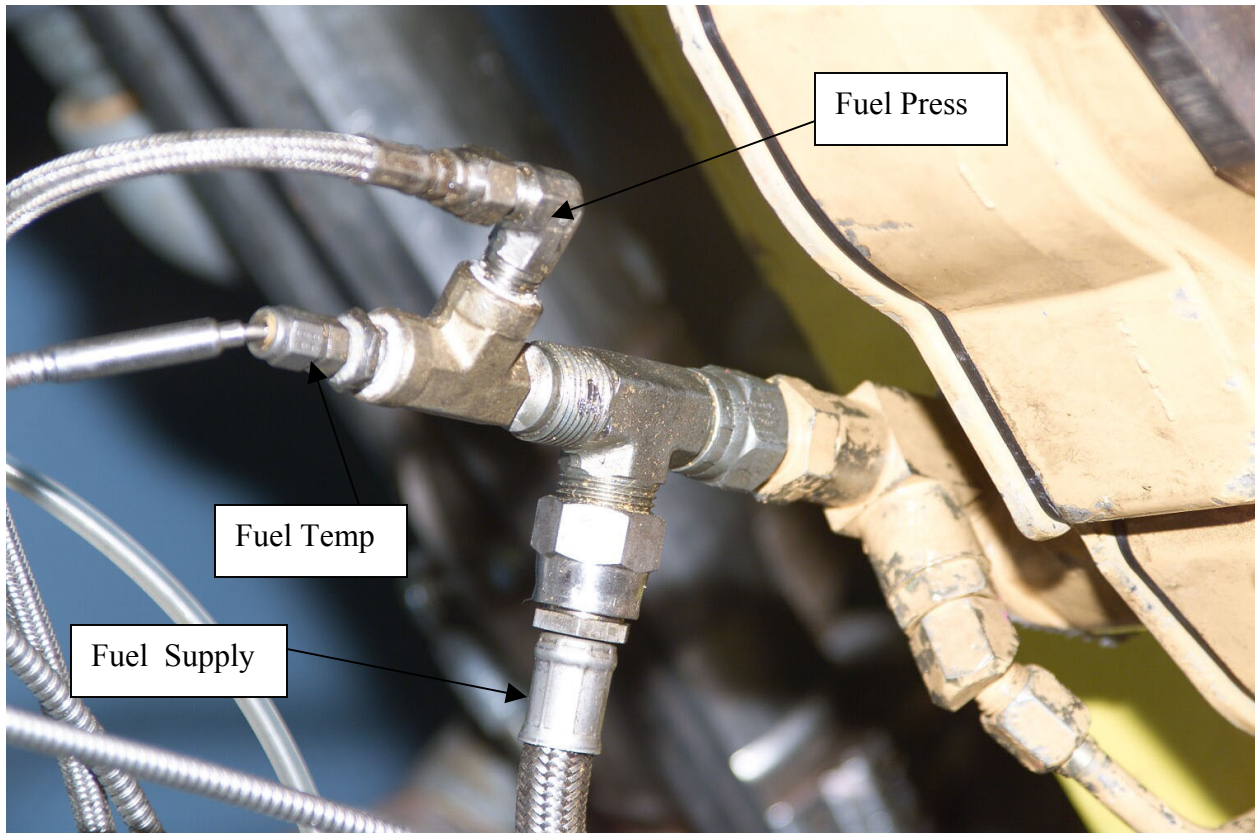

Fig. A4.12 Fuel to Engine Pressure and Temperature

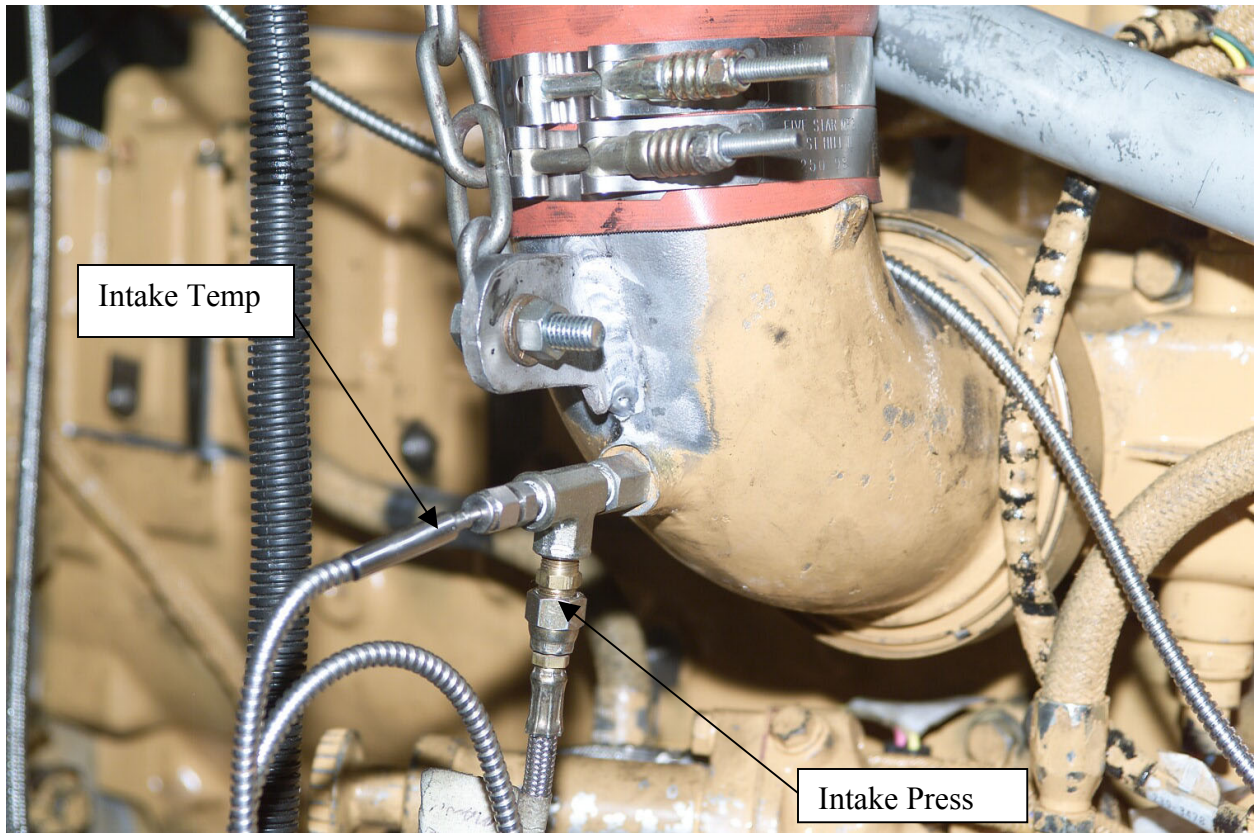

Fig. A4.13 Intake Manifold Pressure and Temperature

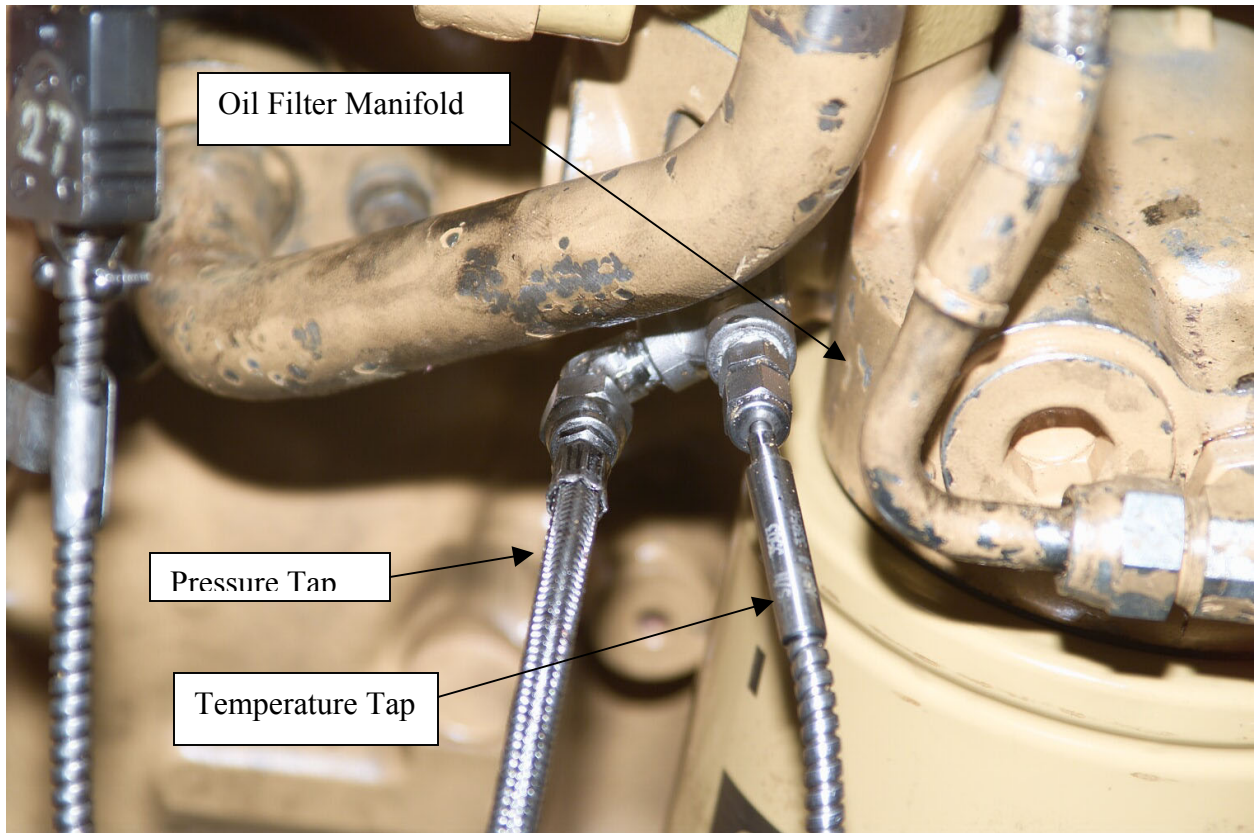

Fig. A4.14 Oil Filter Out Pressure and Temperature

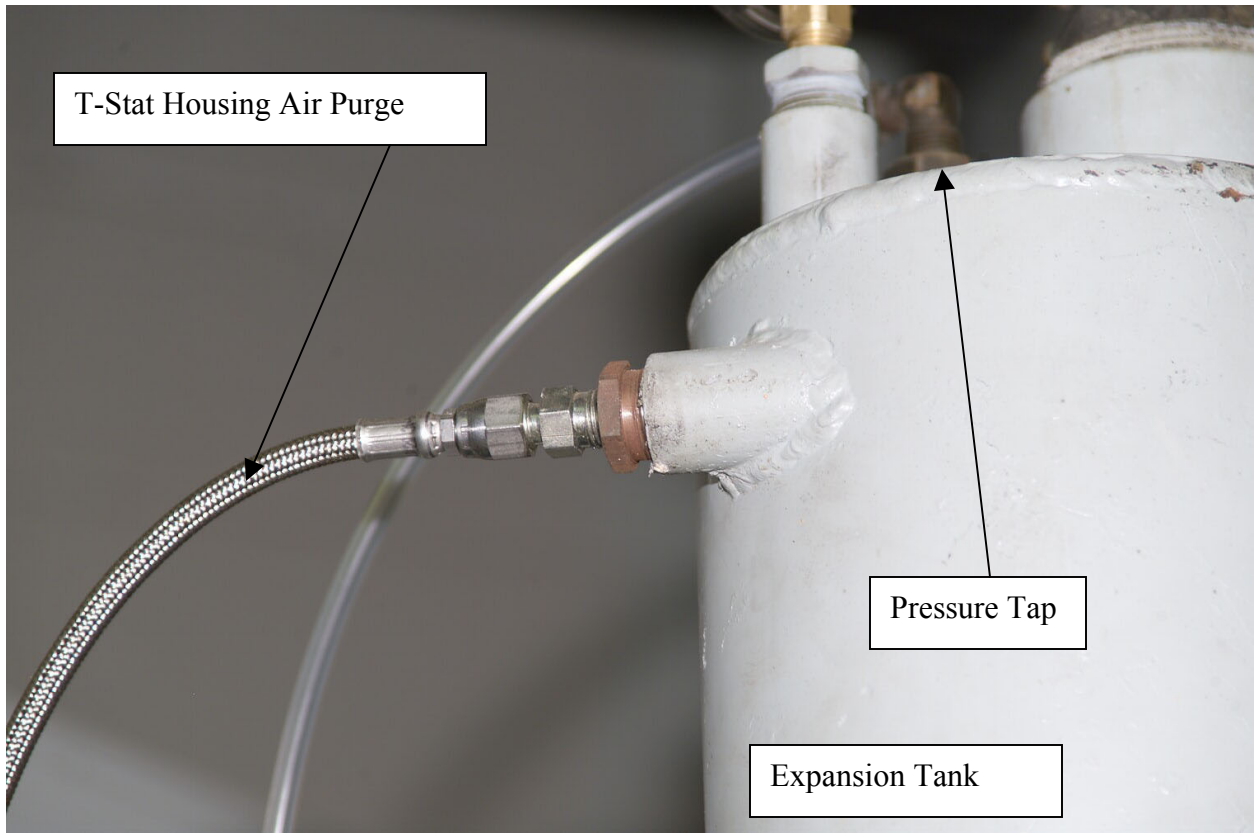

Fig. A4.15 Cooling System Pressure

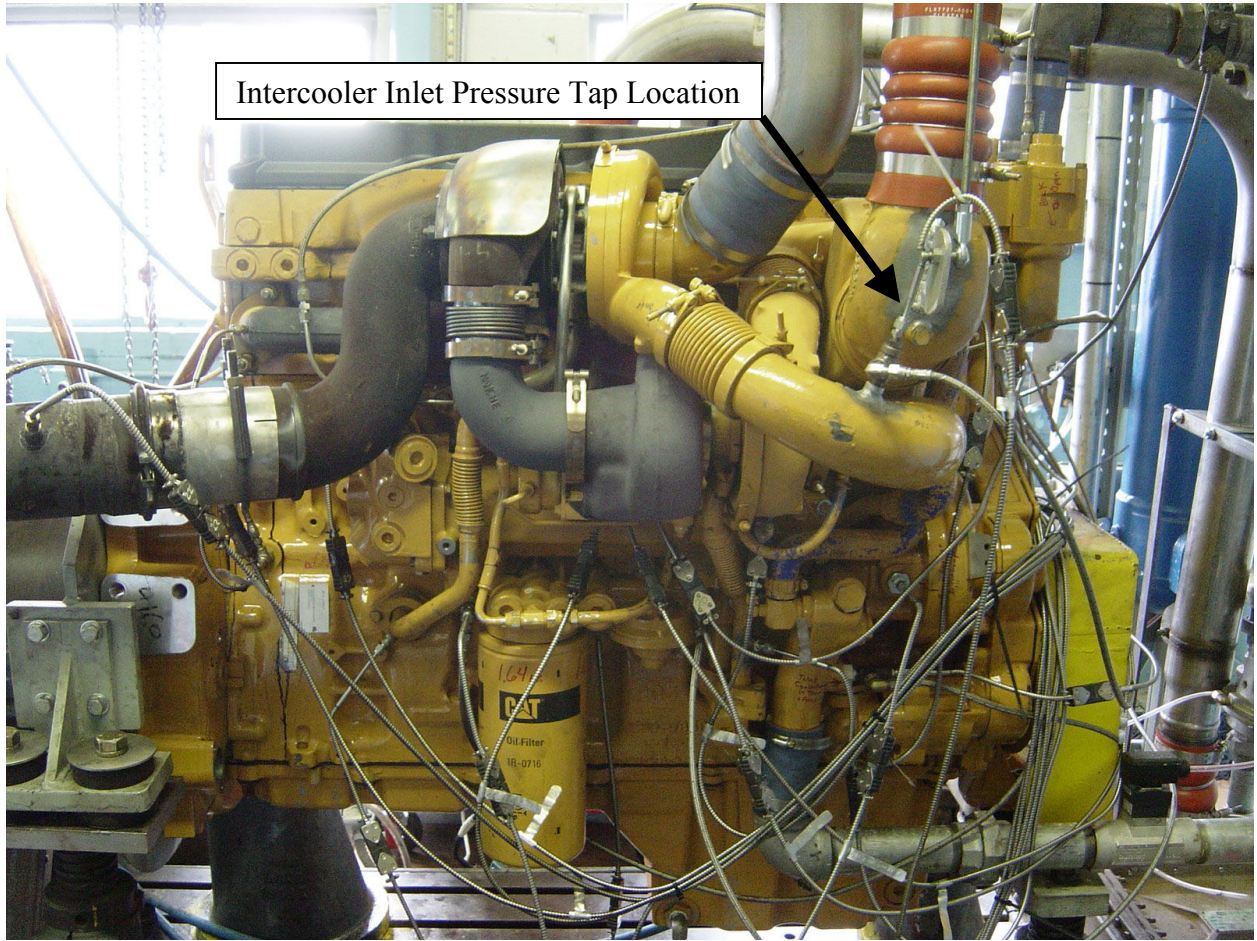

Fig. A4.16 Right Side of Installed Engine

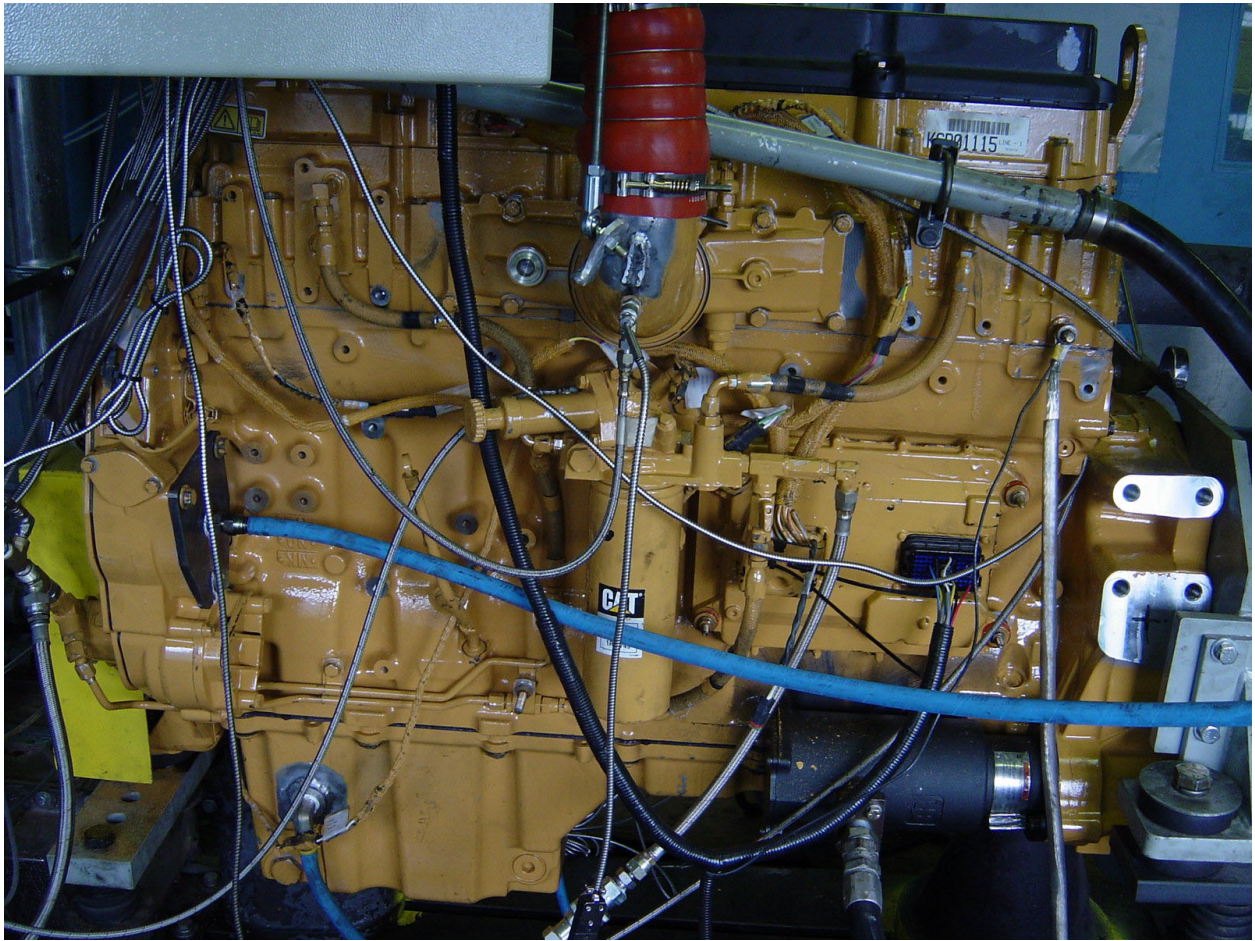

Fig. A4.17 Left Side of Installed Engine

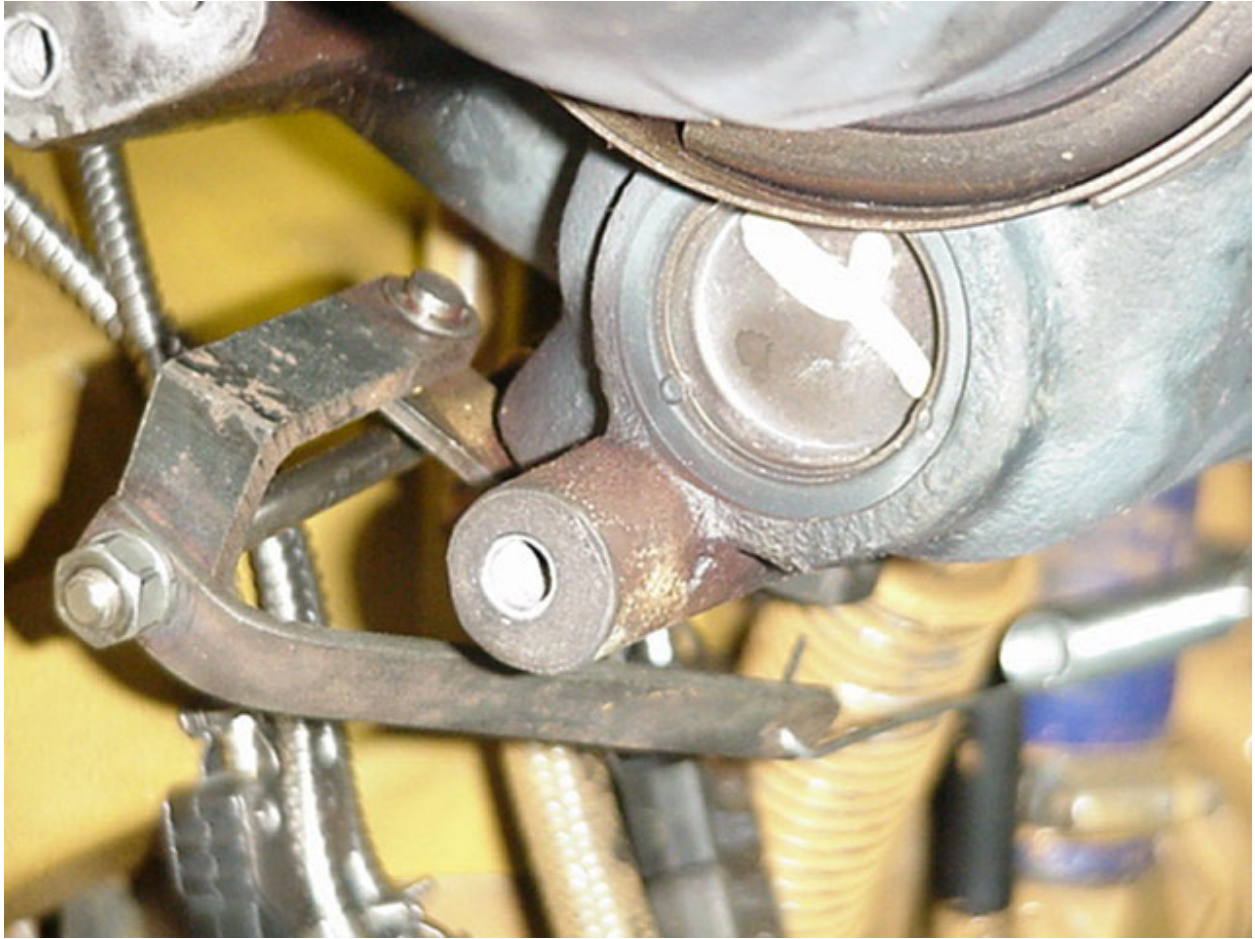

Fig. A4.18 Turbo Wastegate Control

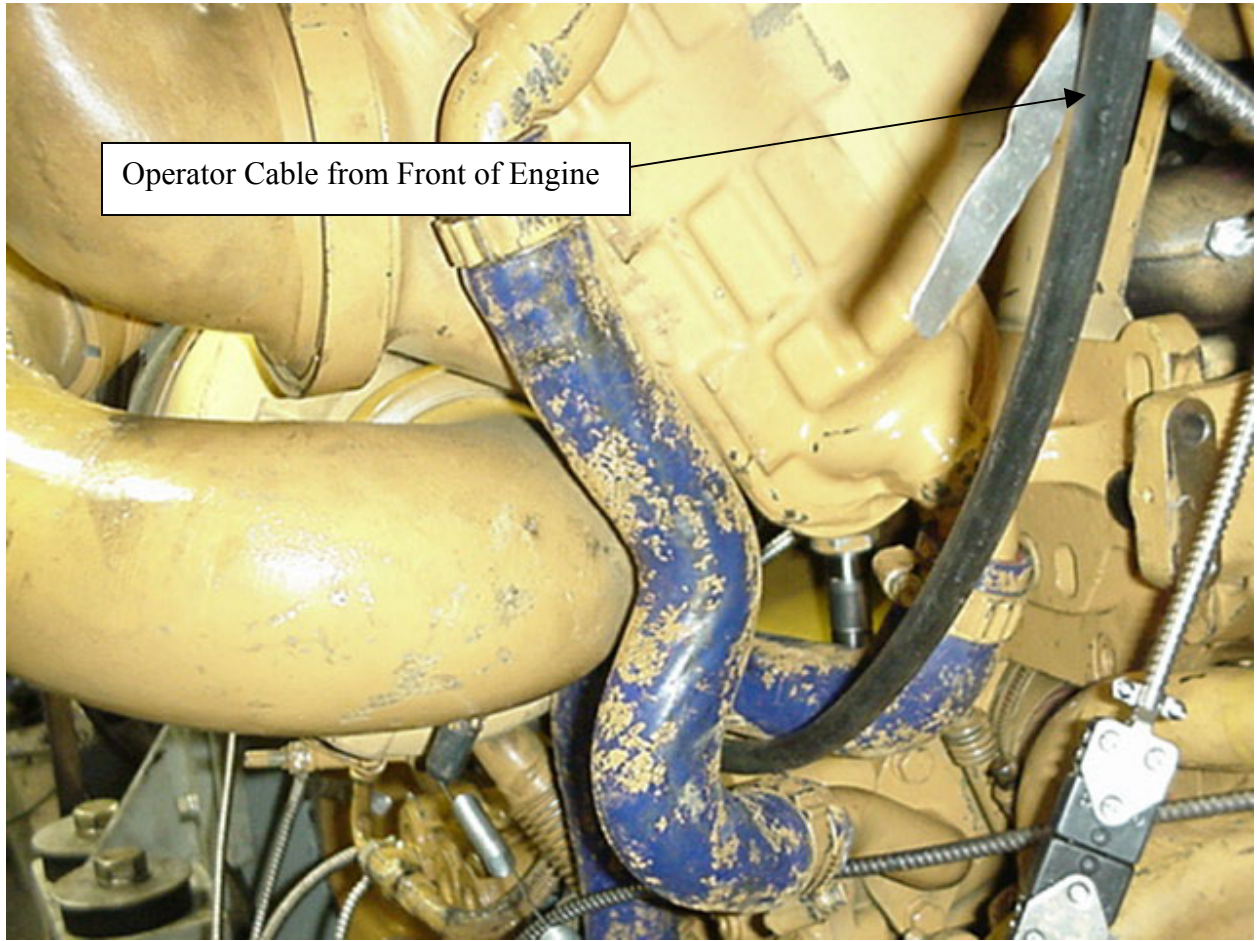

Fig. A4.19 Turbo Wastegate Control Cable

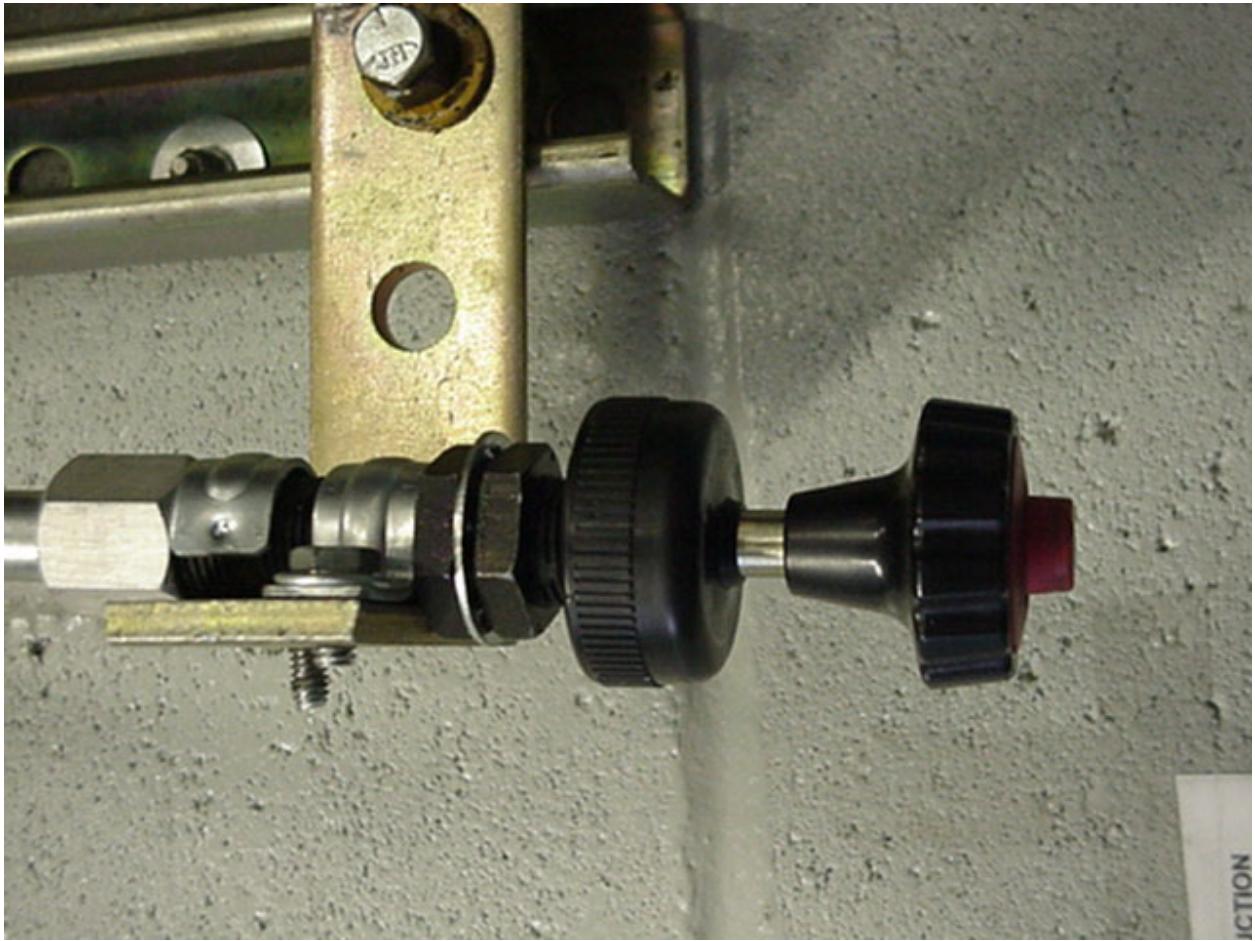

Fig. A4.20 Turbo Wastegate Control Manual Adjuster



Fig. A4.21 Pressurized Oil Fill Location

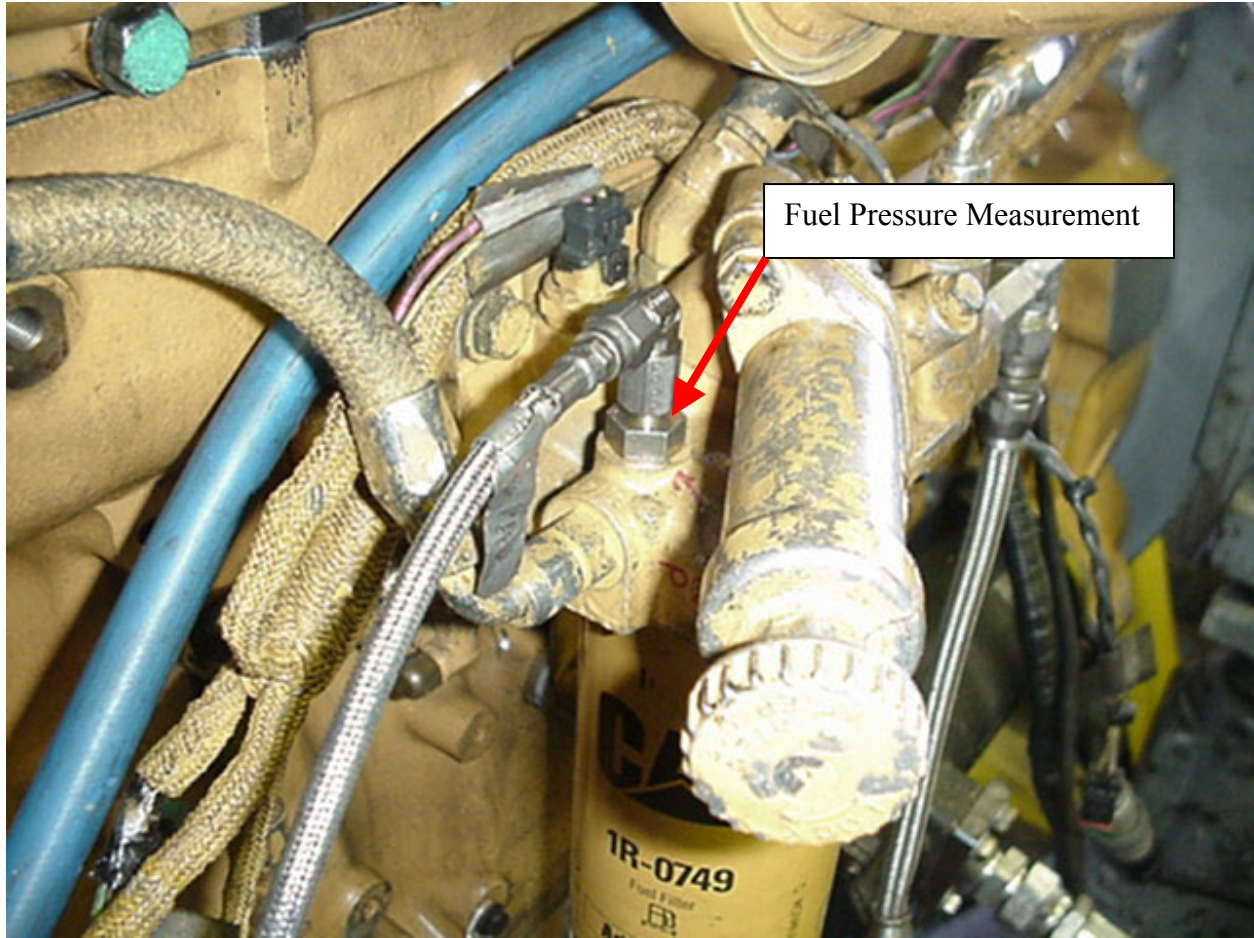
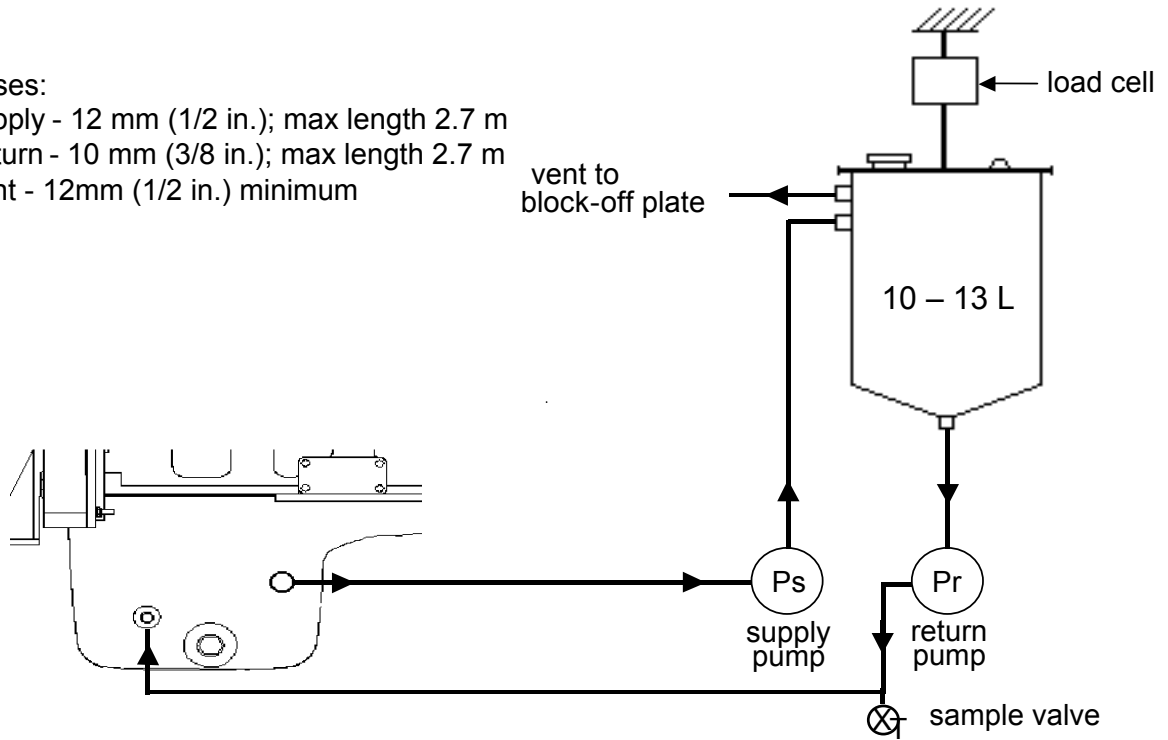

Fig. A4.22 Fuel Pressure Measurement Location

A5. EXTERNAL OIL SYSTEM
FIG. A5.1 External Oil System

Hoses:
Supply - 12 mm (1/2 in.); max length 2.7 m
Return - 10 mm (3/8 in.); max length 2.7 m
Vent - 12mm (1/2 in.) minimum



A6. FUEL SPECIFICATIONS

A6.1 See Table A6.1.

Table A6.1 PC-10 ULSD Fuel Specifications

Measurement	Specifications	Test Method
Total Sulfur, ppm	7 - 15	D 5453
Gravity, °API	34 – 37	D 4052
Hydrocarbon Composition		
Aromatics % Wt.	26 – 31.5	D 5186
Olefins % Vol.	Report	D 1319
Cetane Index	Report	D 976
Cetane No.	43 – 47	D 613
Copper Strip Corrosion	1 Maximum	D 130
Flash Point, °C	54 Minimum	D 93
Pour Point, °C	-18 Maximum	D 97
Carbon Residue on 10% Residuum, %	0.35 Maximum	D 524 (10% Bottoms)
Water & Sediment, % Vol.	0.05 Maximum	D 2709
Viscosity, cSt @ 40°C	2.0 – 2.6	D 445
Total Acid Number	0.05 Maximum	D 664
Strong Acid Number	0.00 Maximum	D 664
Accelerated Stability	1.5 max	D 2274
Ash, % Wt.	0.005 max	D 482
SLBOCLE, g	3100 min^A	D 6078^A
90% Distillation, °C	293 - 332	D 86

^AMay be altered to be consistent with CARB or ASTM diesel fuel specifications.

A7. CATERPILLAR SERVICE PUBLICATIONS

TBD

A8. SPECIFIED UNITS AND FORMATS

A8.1 Specified Units:

A8.1.1 The parameters in this test method are specified in metric units except for pipe fittings, tubing, and tubing fittings. Pipe fittings, tubing and tubing fittings are available worldwide and are not interchangeable with metric-sized equivalents because of differences in thread dimensions. Therefore no metric conversion is stated.

A8.1.2 Test Report — Record operational parameters according to Table A8.1. Report test results in the units and with the significant digits shown in Table A8.2. Round test results in compliance with Practice E29.

A8.1.3 Measurements and Conversions — With the exceptions noted in A8.1.1, all parameters have been specified in S.I. units. The intent of this test method is to measure all parameters directly in S.I. units. If parameters are measured in inch-pound units, then the laboratory shall be able to demonstrate to the TMC that the measurements are within the tolerance after conversion to S.I. units.

A8.1.3.1 Significant error may occur due to rounding or tolerance stacking, or both, when converting from inch-pound units to S.I. units.

Table A8.1
Minimum Resolution of Recorded Measurements

Parameter	Record data to Nearest
Speed	1 r/min
Power	1 kW
Torque	1 N•m
Fuel Flow	1 g/min
Coolant In Temperature	0.1 °C
Coolant Out Temperature	0.1 °C
Fuel In Temperature	0.1 °C
Oil Gallery Temperature	0.1 °C
Intake Air Temperature	0.1 °C
Exhaust (Tailpipe) Temperature	1 °C
Intake Manifold Pressure	0.1 kPa
Crankcase Pressure	0.01 kPa
Exhaust Pressure	0.1 kPa

Table A8.2
Significant Digits for Test Results

Parameter	Round off to Nearest
Mass Loss	0.1 mg
Oil Consumption	0.1 g
Piston Ratings	0.1 rating unit

A8.2 Specification Format — Specifications are listed in three formats:

- (1) target
- (2) target and range

(3) range with no target.

A8.2.1 Target – A target specification has no tolerance. Therefore the only acceptable value is the target. A representative specification format is xx.xx (target). For example, the oil pan oil charge is listed as 30.8 kg.

A8.2.1.1 A parameter with a target shall not be intentionally calibrated or controlled at a level other than the target.

A8.2.2 Target and Range – A target and a range specification implies the correct value is the target and the range is intended as a guide for maximum acceptable variation about the mean. A representative specification format is xx.xx ± x.xx (target ± range). For example, the engine speed is 1800 ± 5 r/min.

Note A8.2: The mean of a random sample should be equivalent to the target. Operation within the range does not imply that parameter will not bias the final test results.

A8.2.3 Range with No Target – A range with no target specification is used when 1) the parameter is not critical and control within the range is sufficient or 2) the measurement technique is not precise, or both. A representative specification format is xx.xx - xx.xx (range_{low} – range_{high}). For example, the coolant system pressure is 99 – 107 kPa.

A9. REPORT FIGURES (FORMS) AND DATA DICTIONARY

A9.1 Download the actual report figures (forms) and data dictionary separately from the ASTM Test Monitoring Center Web Page at <http://www.tmc.astm.cmri.emu.edu/> or they can be obtained in hardcopy format from the TMC.

Table A9.1 List of Report Forms

Form 1	Test Validation and Details (Cover page)
Form 2	Table of contents
Form 3	Summary of Test Method
Form 4	Test Results Summary
Form 5	Operational Summary
Form 6	Rod Bearing Weight Loss
Form 7	Ring Weight Loss
Form 8	Ring Side Clearance
Form 9	Oil Analysis Summary
Form 10	Liner Wear Summary
Form 11	Unscheduled Downtime & Maintenance Summary
Form 12	Test Fuel Analysis (last batch)
Form 13	Build-up and Hardware information
Form 14	Piston Deposit Rating Summary
Form 15	Rating Summary: Piston #1
Form 16	Rating Summary: Piston #2
Form 17	Rating Summary: Piston #3
Form 18	Rating Summary: Piston #4
Form 19	Rating Summary: Piston #5
Form 20	Rating Summary: Piston #6
Form 21	Supplemental Rating Summary: Piston #1
Form 22	Supplemental Rating Summary: Piston #2
Form 23	Supplemental Rating Summary: Piston #3
Form 24	Supplemental Rating Summary: Piston #4
Form 25	Supplemental Rating Summary: Piston #5
Form 26	Supplemental Rating Summary: Piston #6
Form 27	Oil Consumption Plot

A10. Piston Ring Loss of Side Clearance and Piston Ring Sticking Worksheets

A10.1 Cylinder Liner Modifications for Measurement of Ring Side Clearance - TBD

A10.2 Ring Side Clearance Worksheet - TBD

A10.3 Ring Sticking Worksheet - TBD

A11. PISTON RATING LOCATIONS

A11.1 Each piston/ring combination is to be rated for ring sticking and sluggish rings as removed from the engine and then again after a solvent rinse. Each piston/ring combination is then to be measured for loss of side clearance. The piston rings are then removed and the pistons rated. See Table A11.1

Table A11.1 PISTON RATING LOCATIONS

Location / Deposit	Special Instructions
Grooves:	
Top Groove Fill	
Intermediate Groove Fill	
“C” Groove Fill	
Groove No. 1	Rate HC, MC, LC & Lacquer
Groove No. 2	Rate HC, LC
Groove No. 3	Rate HC, MC, LC
Lands:	
Top Land Heavy Carbon	
Top Land % Flaked Carbon	
Lands No. 1 – No. 4	Rate HC, LC
Lands No.1 No. 2	Lacquer
Other:	
Undercrown	Rate separately from grooves and lands

A12. OIL ANALYSES
A12.1 See Table A12.1

Table A12.1
OIL ANALYSIS

Parameter
Analyze all samples for: 100°C and 40°C viscosity by Test Method D445 TBN by Test Method D4739 TAN by Test Method D664 Wear metals Al, Cr, Cu, Fe, Pb, Si by Test Method D5185 Oxidation and Nitration level by differential IR (E 168) using the peak-area method 5 Fuel dilution by Test Method D3524 TGA soot by Annex A4 of Test Method D5967 Optional analysis such as wear metals for mechanical problems.

A13. DETERMINATION OF OPERATIONAL VALIDITY

NOTE 1: THIS SECTION IS STILL UNDER DEVELOPMENT. PC-10 MATRIX DATA WILL BE USED TO COMPLETE THIS SECTION; UNTIL COMPLETED TEST VALIDITY IS DETERMINED BY JUDGING OPERATIONAL DATA AGAINST THE OPERATING CONDITIONS SHOWN IN TABLE 4.

NOTE 2: FOR THE PC-10 MATRIX IT IS RECOMMENDED THAT NO TEST EXCEED 125 HOURS OF DOWNTIME. ANY TEST THAT EXCEEDS THIS VALUE WILL BE EXAMINED BY THE TASK FORCE TO ASSESS ITS VALIDITY.

A13.1 Quality Index Calculation

A13.1.1 Calculate Quality Index (QI) for all control parameters according to the DACA II Report. Account for missing or bad quality data according to the DACA II Report.

A13.1.2 Use the U, L, Over Range, and Under Range values shown in Table A14.1 for the QI calculations.

A13.1.3 Round the calculated QI values to the nearest 0.001.

A13.1.4 Report the QI values on Fig. A9.5 (Form 5) listed in A9.1.

A13.2 Averages

A13.2.1 Calculate the average for control and non-control parameters, and report the values on Form 5 shown in Table A9.1. Note that the averages are not directly used to determine operational validity but may be helpful when an engineering review is required (A13.4).

A13.3 Determining Operational Validity

A13.3.1 QI threshold values for operational validity are shown in Table A14.1.

A13.3.1.1 A test with all control parameter QI values greater than or equal to the threshold value is operationally valid.

A13.3.1.2 Perform an engineering review to determine operational validity for a test with any control parameter QI value less than the threshold value shown in Table A14.1.

A13.4 Engineering Review

A13.4.1 An engineering review shall be performed when a control parameter QI value is below the threshold value. A typical engineering review involves investigation of the test data to determine the cause of the QI value below threshold. The purpose of the review is to determine whether a real control problem existed and the possible impact on the test. For example, a test has a low QI value for fuel flow. An examination of the fuel flow data may show that the fuel flow data contains several over range values. An examination of exhaust temperatures may help determine whether the instrumentation problem affected real fuel flow or only affected the data acquisition.

A13.4.2 Conduct engineering reviews for reference tests jointly with the TMC. For non-reference tests, optional input is available from the TMC for the engineering review.

A13.4.2 Determine operational validity based upon the engineering review and summarize the decision in the comment section of Fig. A9.1 (Form 1) listed in A9.1. Supporting documentation may be included at the end of the test report. The final decision regarding operational validity rests with the laboratory.

**TABLE A13.1
QUALITY INDEX CALCULATION VALUES**

Control Parameter	Units	Quality Index Threshold	Quality Index U & L Values ^B				Over & Under Range Values ^C	
			U		L		Low	High
Speed ^A	r/min	0.000	TBD	TBD	TBD	TBD	TBD	TBD
Fuel Flow ^A	kg/h	0.000	TBD		TBD		TBD	TBD
Coolant Out Temp.	°C	0.000	TBD		TBD		TBD	TBD
Fuel In Temp.	°C	0.000	TBD		TBD		TBD	TBD
Oil Gallery Temp.	°C	0.000	TBD		TBD		TBD	TBD
Intake Manifold Temp.	°C	0.000	TBD		TBD		TBD	TBD
Exhaust Back Pressure	kPa	0.000	TBD		TBD		TBD	TBD

^AU and L values for speed are split by test stage.

^B Quality Index U & L Values To Be Determined

^C Over & Under Range Values To Be determined

A14 OIL TEMPERATURE CONTROL SYSTEM

A14.1 System Details - details of the auxiliary oil heat exchanger setup are shown in Figs. A14.1 through A14.4.

A14.2 Heat Exchanger – use an ITT Standard SSCF heat exchanger, p/n SN5160030014004.

A14.3 Oil Lines and Fittings – Use two No. 16 size lines with a maximum length of 36 in. (total of both lines). Use No. 16 NPT threaded fittings for the line connections. It is recommended that stainless steel braided hose be used for the oil lines.

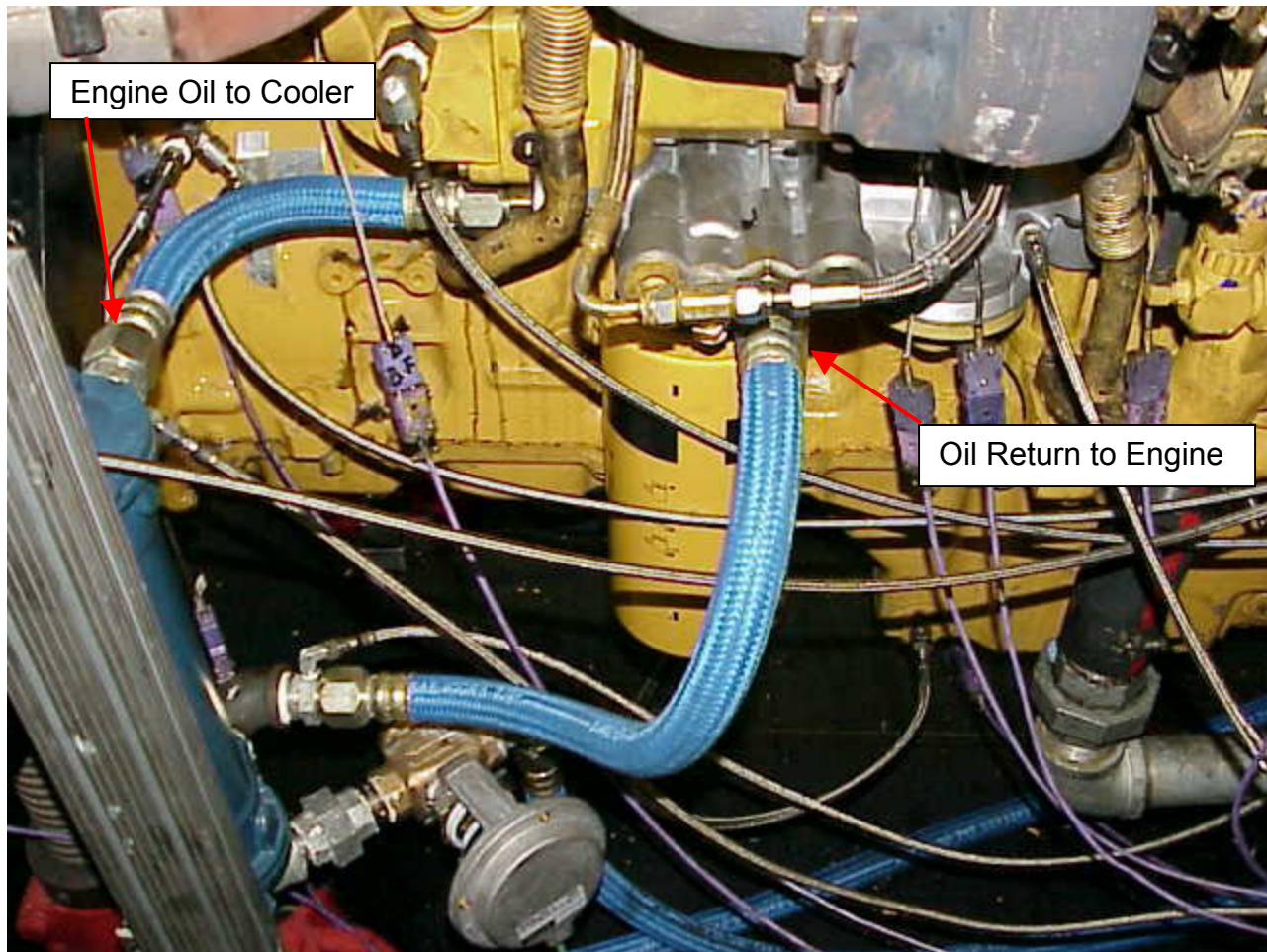

Fig A14.1 Remote Oil Heat Exchanger

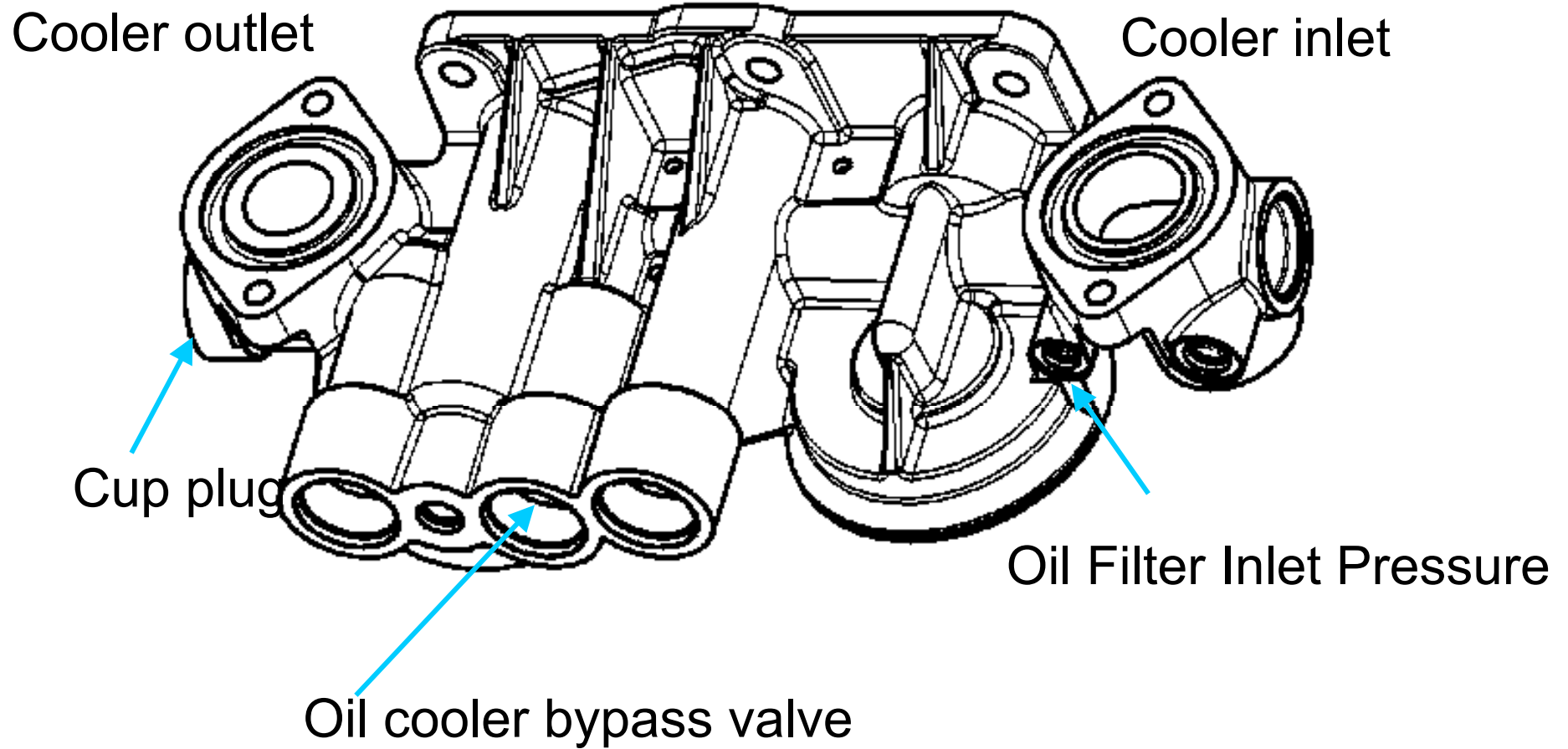

Fig. A14.2 Filter Base (p/n 251-6668) View

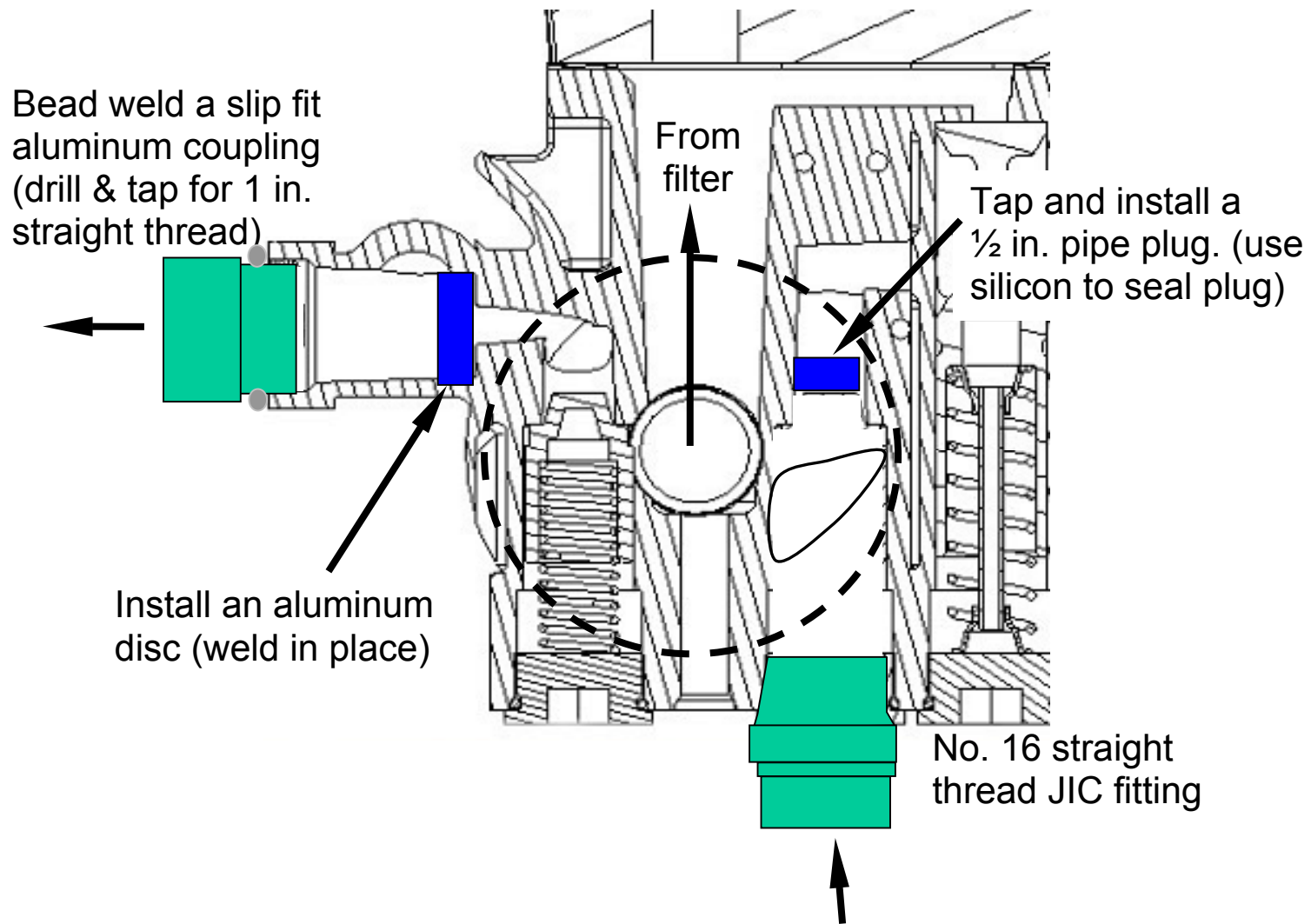
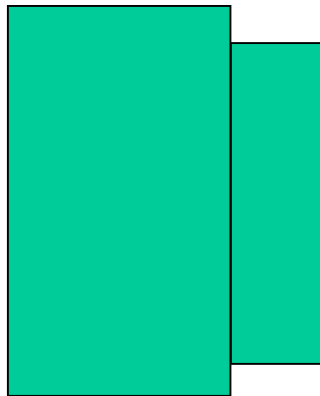
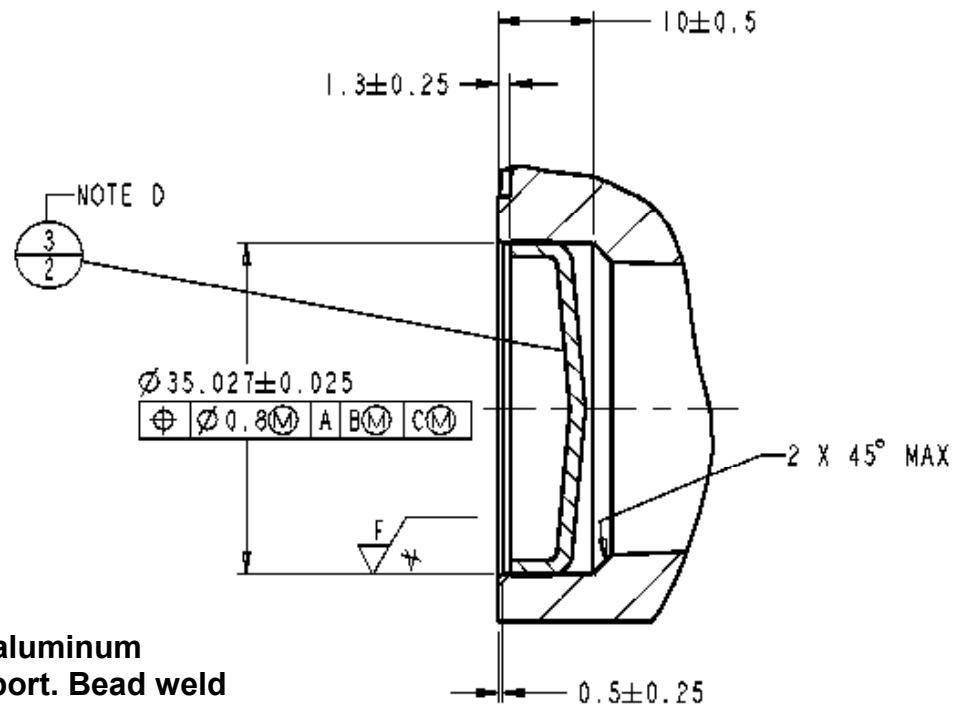

Fig. A14.3 Filter Base Modifications



Fabricate a 1" straight thread aluminum coupling that will slip into the port. Bead weld the coupling in place.



DETAIL P

SCALE 2:1
SH 2 D-8

Fig A14.4 Details of Cup Plug Feature at Back End of Filter Base

APPENDIXES
(Non Mandatory Information)

X1. Typical System Configurations:

X1.1 Intake Air System (Fig. X1.1)

X1.2 Fuel System (Fig. X1.2)

X1.3 Coolant System (Fig X1.3)

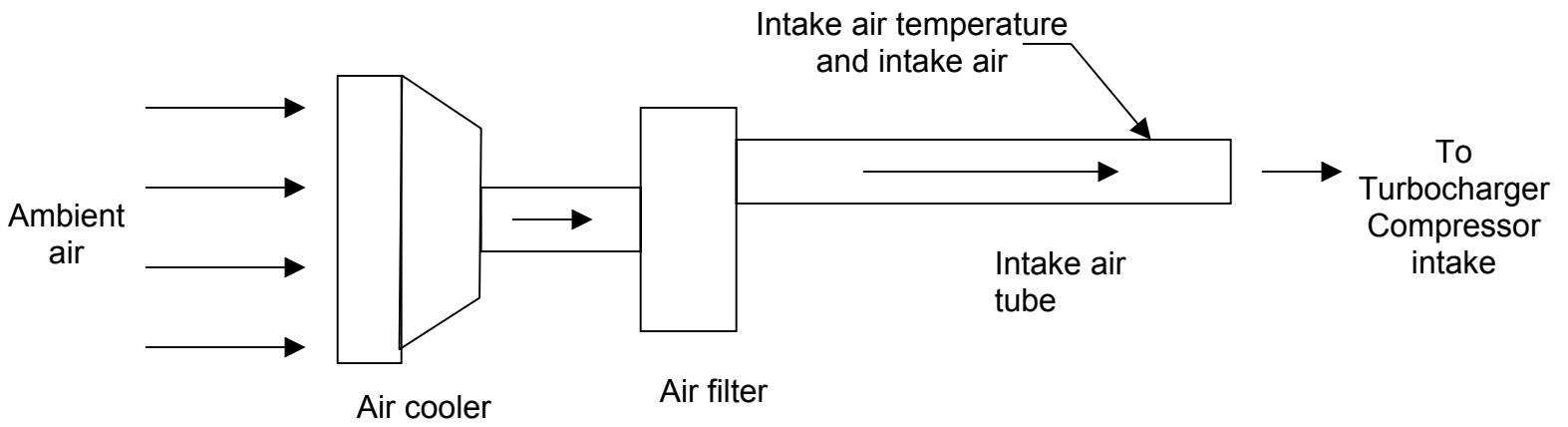

Fig. X1.1 Intake Air System (Typical)

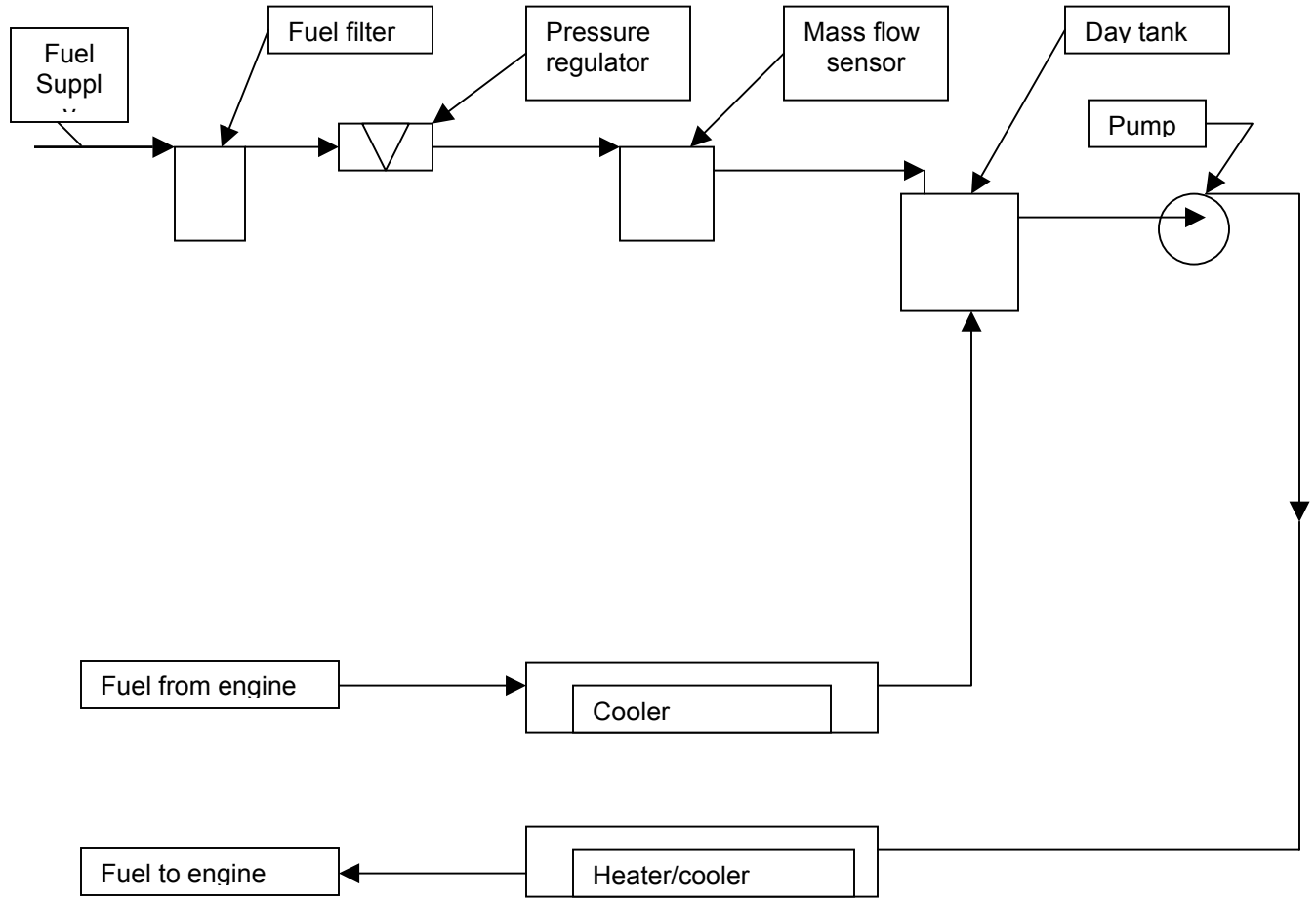

Fig. X1.2 Fuel System (Typical)

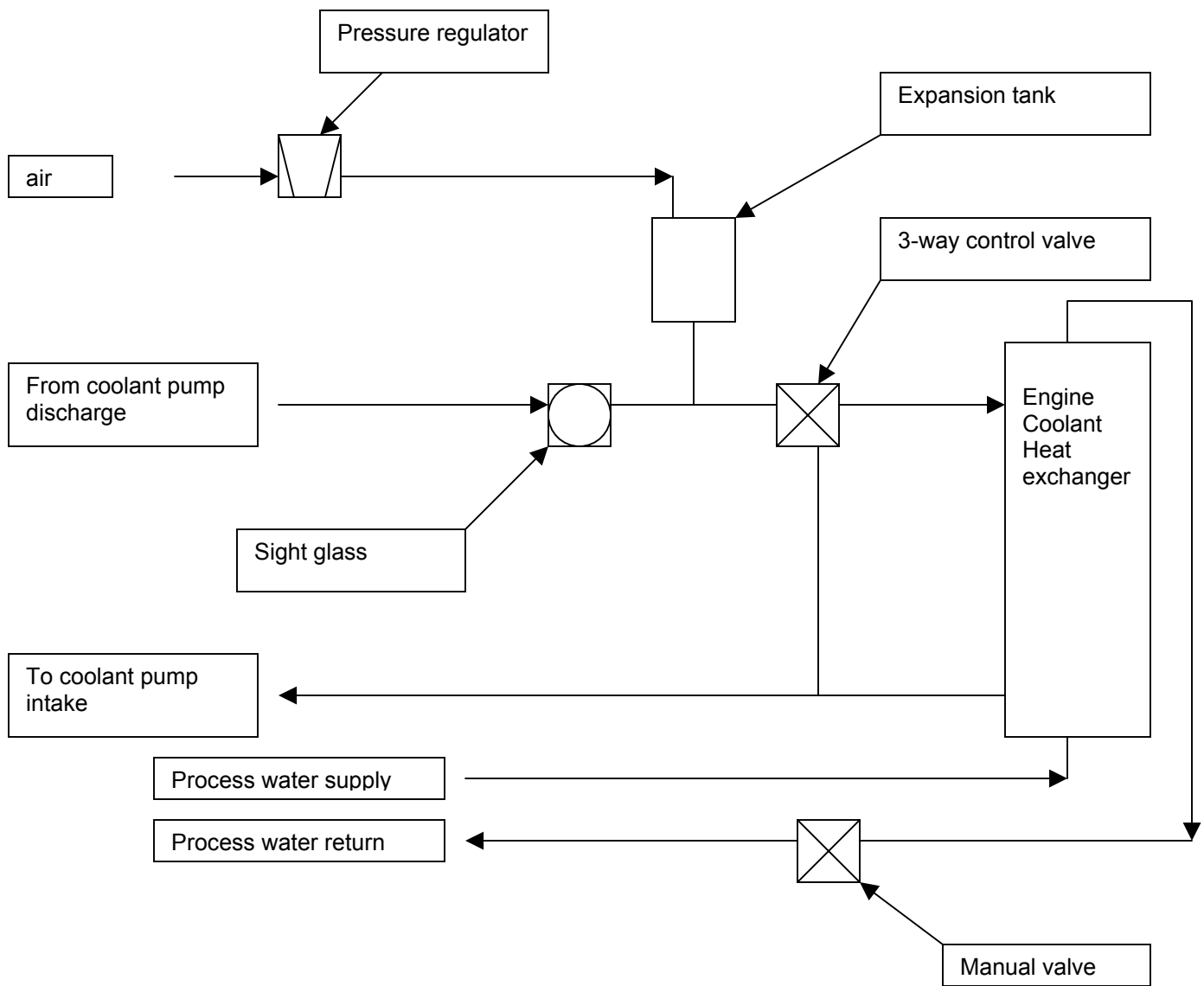

Fig. X1.3 Coolant System (Typical)

Caterpillar C13 Footnotes

¹ This test method is under the jurisdiction of ASTM Committee D02 on Petroleum Products and Lubricants and is the direct responsibility of Subcommittee D02.0B on Automotive Lubricants. Current edition approved XXX. Published YYYY.

² American Society for Testing and Materials takes no position respecting the validity of any patent rights asserted in connection with any item mentioned in this standard. Users of this standard are expressly advised that determination of the validity of any such patent rights, and the risk of infringement of such rights, are entirely their own responsibility.

³ The ASTM Test Monitoring Center will update changes in this test method by means of Information Letters. Information letters may be obtained from the ASTM Test Monitoring Center, 6555 Penn Avenue, Pittsburgh, PA 15206-4489, Attention: Administrator.

⁴ Annual Book of ASTM Standards, Vol 05.01

⁵ Annual Book of ASTM Standards, Vol 05.04

⁶ Annual Book of ASTM Standards, Vol 05.02

⁷ Annual Book of ASTM Standards, Vol 05.03

⁸ Annual Book of ASTM Standards, Vol 14.02

⁹ Annual Book of ASTM Standards, Vol 14.03

¹⁰ Available from the Coordinating Research Council, Inc., 219 Perimeter Parkway, Atlanta, Georgia 30346.

¹¹ Available from Superintendent of Documents, Attn: New Orders, P.O. Box 371954, Pittsburgh, PA 15250-7954. Charge orders may be telephoned to the Government Printing Office order desk at 202-512-1800.

¹² Information available from Caterpillar, Inc. attention Charles Dutart

¹³ Available from ExxonMobil Corporation.....

¹⁴ Available from a Caterpillar parts distributor.

¹⁵ Available from the ASTM Test Monitoring Center, 6555 Penn Avenue, Pittsburgh, PA 15206-4489, Attention: Administrator.

¹⁶ Available from Chevron Phillips, 1302 McKinney Street, Suite 2130, Houston, TX 77010-3030 Phone: (713) 289-4859, Fax: (713) 289-4865

¹⁷ Available from ASTM, 100 Barr Harbor Drive, West Conshohocken, PA 19428-2959.

¹⁸ ASTM Test Monitoring Center, 6555 Penn Avenue, Pittsburgh, PA 15206-4489 Phone: (412) 365-1000, Fax: (412) 365-1047.